



CATÁLOGO 2022

 Chimeplast®

 Aeroplast

 ALUONE

 Keramik

 ChimeNOX®

 Ei-30

 HP

 COMPLEMENTOS





NUESTRA HISTORIA

Cada elección está guiada por la ambición de garantizar constantemente la máxima calidad y fiabilidad del producto



Fig, S.L. nace en 1966 y en pocos años se especializa en la fabricación de conductos para la evacuación de humos de calderas y calentadores de gas y gasoil, estándar y de condensación.

Somos la única empresa nacional que puede ofrecer **calidad y seguridad O.E.M.** Esto significa que nuestros conductos de evacuación, además de estar homologados y conforme a la normativa vigente, son equivalentes en calidad y seguridad a los ofrecidos por los fabricantes de aparatos.

Tantos años trabajando en este campo nos han permitido acumular los conocimientos necesarios para poder ofrecer un **servicio gratuito de asesoría** para el cálculo y la realización de instalaciones correctas de conductos de evacuación de humos, según los aparatos elegidos y las condiciones de instalación.

FIG Y GROPPALLI

En 2008 FIG fue adquirida por **GROPPALLI S.R.L.**, una empresa que lleva operando desde 1977 en el sector de la construcción de moldes, GROPPALLI se caracteriza inmediatamente por un fuerte dinamismo en las inversiones, lo que determina un crecimiento tecnológico muy fuerte.

Diez años después, GROPPALLI desarrolla su propia línea de conductos de humos, entrando en

el sector de componentes para calderas murales. El crecimiento de la empresa es muy rápido y gracias a **importantes innovaciones** de productos pronto se convierte en líder del sector.

Hoy GROPPALLI es uno de los actores internacionales más importantes y **socio estratégico de los principales fabricantes** de calderas a nivel mundial.

En 2008 se amplió el centro logístico, revolucionando la forma de concebir la relación cliente-proveedor. En particular, gracias a su almacén automático con 37.000 espacios para palets, GROPPALLI puede reducir la cadena de producción al mínimo entregando rápidamente lo que se necesita, donde se necesita, en la cantidad exacta que se necesita.



A NIVEL GLOBAL

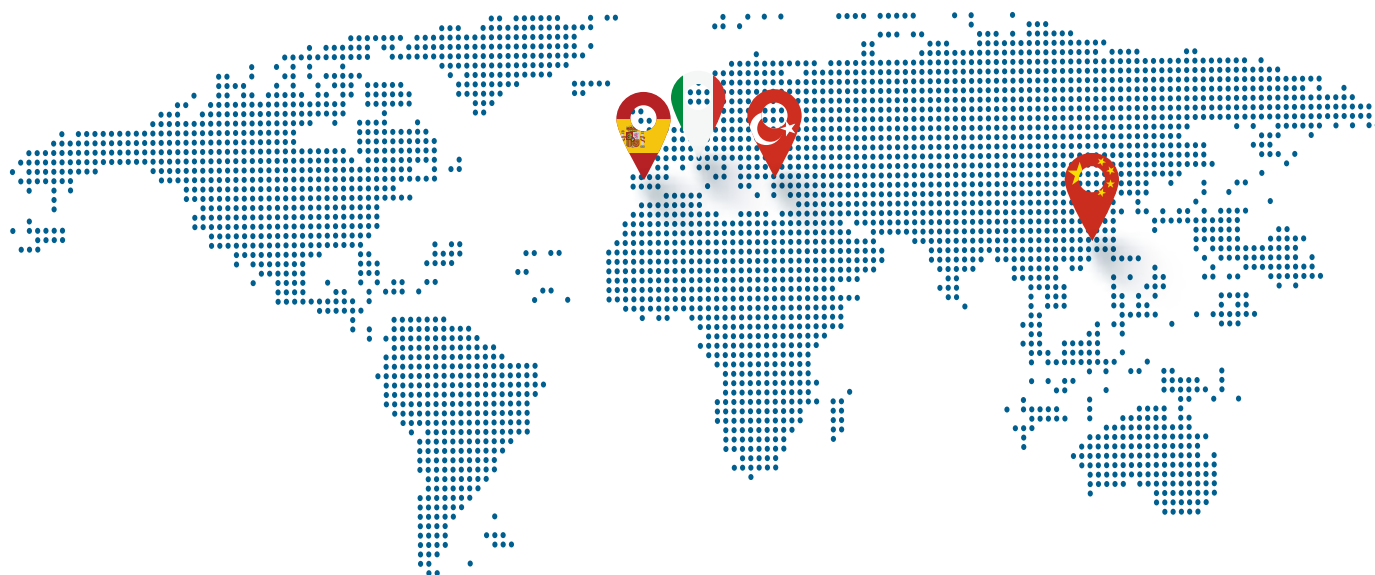

GROPPALLI S.R.L. ITALIA

Corazón de producción y centro de toma de decisiones del grupo, se extiende sobre una superficie de 35.000 metros cuadrados y está equipado con las más modernas tecnologías de producción para dar respuesta a cualquier necesidad del cliente.

GROPPALLI TURQUÍA

Lanzada en 2006 para servir directamente al mercado turco, ahora posee una fábrica de 10.000 metros cuadrados.

En 2010 se fundó G.ALL para abastecer al grupo y al mercado nacional de perfiles de aluminio para diversos sectores, incluidos los de automoción y calefacción.

GROPPALLI HVAC

La última incorporación al grupo se encuentra en Chang Zhou, China. La empresa, operativa desde 2015, con sus 20.000 metros cuadrados lleva a Oriente la calidad de los productos Groppalli fabricados in situ según los estándares europeos y las características que distinguen al Made in Italy.

RED COMERCIAL

Cataluña

Alfonso Muñoz Almaraz
Tfn: 660 418 689
comercial@amcomercial.cat

Aragón y Soria

José Luis Legaz
Tfn: 607 158 834
figaragon@gmail.com

Madrid, Castilla la Mancha, Ávila y Segovia

Juan Carlos de la Torre
Tfn: 629 521 863
dlt@dlt-representa.es

Andalucía

Juan Francisco Sanchez García
Tfn: 673 046 776
juanfrsanchezgar@gmail.com

País Vasco, Navarra, Cantabria, La Rioja y Burgos

Juan Carlos Riveiro
Tfn: 649 864 168
jcarlosriveiro17@gmail.com

Valencia y Castellón

Germán Pastor
Tfn: 606 953 091
g.pastor@cgac.es

Alicante

Antonio Albaladejo
Tfn: 617 232 901
aalbaladejobru@gmail.com

Galicia, Asturias y León

José Luis Martínez
Tfn: 600 455 554
joseluis@poloarpentis.es

Islas Canarias

FIG
Tfn: 976 107 046
fig@fig.es

Extremadura

Vicente Bermejo Sánchez
Tfn: 650 944 038 – 664 620 491
vicentebermejo@telefonica.net

Salamanca, Valladolid, Zamora y Palencia

Fernando Anton Payan
Tfn: 660 168 399
fernan.salamanca@gmail.com

Murcia

Juan Jose Zomeño
Tfn: 607 408 611
zrepresentaciones@gmail.com

Islas Baleares

Marc Comas Cabot
Tfn: 657 970 940
comasch@gmail.com

Portugal

Miguel Bazenga Fernandes
Tfn: +351 968 494 996
mbfernandes57@gmail.com



ASESORAMIENTO

TÉCNICO

Ayudamos a **resolver los problemas** que puedan derivarse de instalaciones complejas gracias a nuestras soluciones que ahorran espacio y tiempos de montaje.

Conocemos, asesoramos y aplicamos todas las normativas vigentes que afecta a las instalaciones de evacuación de humos y resistencia al fuego.

Gracias a nuestro KNOW HOW y la larga experiencia, ofrecemos las **mejores soluciones** en aquellos casos donde la instalación de un conducto se complica.



DESIGNACIÓN PRODUCTO

En la UNE 123001:2012 “Cálculo, diseño e instalación de chimeneas modulares”, en su **apartado 4**, nos indica que todas las chimeneas, independientemente del material de su pared interior, se designan conforme a la Norma UNE-EN 1443 “Chimeneas. Requisitos generales”.

Las chimeneas metálicas tienen una designación específica según las Normas UNE-EN 1856-1 “Requisitos para chimeneas metálicas. Parte 1: Chimeneas modulares” y UNE-EN 1856-2 “Requisitos para chimeneas metálicas. Parte 2: Conductos interiores y conductos de unión metálicos”.

Las chimeneas de plástico, tienen asimismo una designación propia según la Norma UNE-EN 14471 “Chimeneas modulares con conductos interiores de plástico. Requisitos y métodos de ensayo”.

CHIMENEA PLÁSTICA

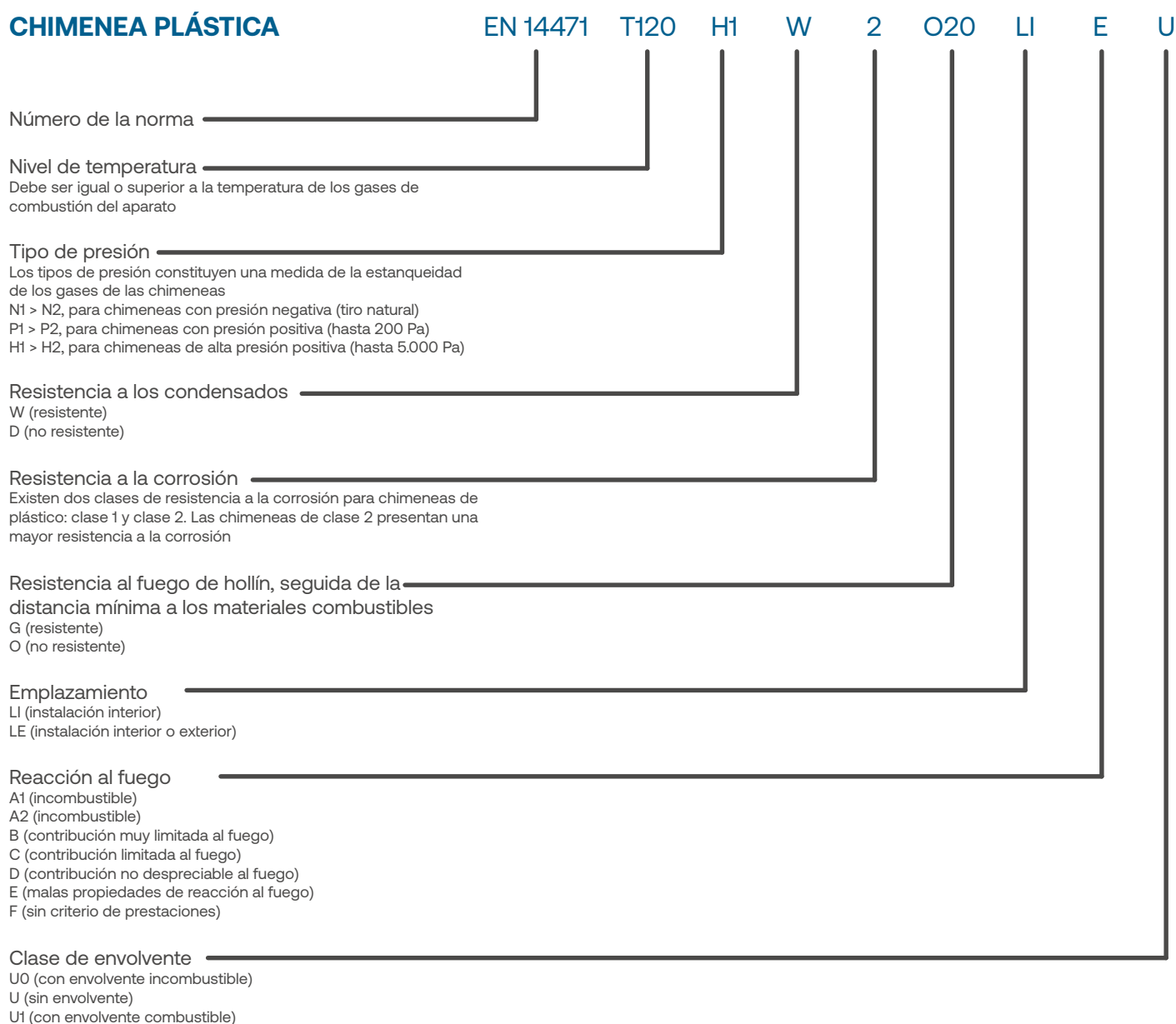

CHIMENEA METÁLICA

EN 1856-1

T200

P1

W

V2-L50050

O50

Número de la norma

Nivel de temperatura

Debe ser igual o superior a la temperatura de los gases de combustión del aparato

Tipo de presión

Los tipos de presión constituyen una medida de la estanqueidad de los gases de las chimeneas

N1 > N2, para chimeneas con presión negativa (tiro natural)

P1 > P2, para chimeneas con presión positiva (hasta 200 Pa)

H1 > H2, para chimeneas de alta presión positiva (hasta 5.000 Pa)

Resistencia a los condensados

W (resistente)

D (no resistente)

Resistencia a la corrosión, seguida de la especificación del material interior

Existen 3 clases de resistencia a la corrosión, clases 1, 2 y 3, en función de la capacidad de la pared interior de la chimenea para resistir el ataque corrosivo de los gases de combustión (3 es la máxima y 1 la clase con menor resistencia)

Resistencia al fuego de hollín, seguida de la distancia mínima a los materiales combustibles

G (resistente)

O (no resistente)



SIMBOLOGÍA

LEYENDA

TIPO COMBUSTIBLE



Gas



Gasoil



Leña



Biomasa

TIPO APARATO



Condensación



No condensación



Ventilación



Estufas de pellets



Calderas de pellets



Hogares



Alta presión



Resistencia al fuego

LUGAR DE INSTALACIÓN



Interior



Exterior



Interior / Exterior



Patinillos compartidos

TIPO DE INSTALACIÓN



Individual



Tramo unión colectiva
Colectiva

MATERIAL ACABADO



PP blanco



Acero lacado blanco



Acero lacado cobre



Aluminio pintado



Aluminio / acero sin
pintar



Inox



PVC Y PP negro



Acero vitrificado negro



Inox negro

ÍNDICE

FAMILIAS



12

APARATOS DE CONDENSACIÓN INSTALACIÓN INDIVIDUAL Y COLECTIVA EN INTERIORES

Chime**plast**[®]

36

APARATOS DE CONDENSACIÓN INSTALACIÓN INDIVIDUAL Y COLECTIVA EN EXTERIORES

Chime**plast**[®]

52

CONDUCTOS Y COMPONENTES PARA BOMBAS DE CALOR ACS

Aero**plast**

94

APARATOS DE CONDENSACIÓN Y BIOMASA INSTALACIÓN INDIVIDUAL Y COLECTIVA EN EXTERIORES

Chime**NOX**[®]

78

ESTUFAS Y CALDERAS DE PELLETS / BIOMASA

Keramik

58

APARATOS TRADICIONALES INSTALACIÓN INDIVIDUAL EN INTERIORES

ALUONE

126

GRUPOS ELECTRÓGENOS

HP

134

CAMPANAS EN COCINAS INDUSTRIALES Y SECTORIZACIONES

Ei-30

142

COMPLEMENTOS

Chimeplast[®]

Instalaciones individuales

CONDUCTOS Y COMPONENTES PARA APARATOS DE CONDENSACIÓN EN
INSTALACIONES INDIVIDUALES Y COLECTIVAS



SIMPLE PARED

Conductos y componentes para sistemas de EVACUACIÓN de humos de aparatos de condensación (caldera mural estanca de condensación) en instalaciones INDIVIDUALES y tramos de unión en instalaciones COLECTIVAS por INTERIOR.

Estas instalaciones son en BIFLUJO (La admisión de aire y la extracción de humos de la caldera se realizan por dos tubos separados).

Características:

- Material:
 - Polipropileno (PP).
- Espesor mínimo pared conducto: 1,5 mm.
- Combustible: Gas o Gasoil.
- Temperatura máxima: 120°C.
- Juntas: EPDM.
- Colores:
 - Blanco.
- Designación de producto:
 - T120-H1-W-2-020-LI-E-U
- Diámetros disponibles:
 - Ø50 - Ø60 - Ø80 - Ø100

PROTEGIDO

Conductos y componentes para sistemas de EVACUACIÓN de humos de aparatos de condensación (caldera mural estanca de condensación) en instalaciones INDIVIDUALES y tramos de unión en instalaciones COLECTIVAS por EXTERIOR o PATINILLOS COMPARTIDOS.

Estas instalaciones son en BIFLUJO (La admisión de aire y la extracción de humos de la caldera se realizan por dos tubos separados).

Características:

- Material:
 - Polipropileno (PP) (interior)
 - Acero lacado (exterior)
- Espesor mínimo pared conducto: 1,5 mm.
- Combustible: Gas o Gasoil.
- Temperatura máxima: 120°C.
- Juntas: EPDM.
- Colores:
 - Blanco (PP interior)
 - Blanco / Cobreado (Acero lacado).
- Designación de producto:
 - T120-H1-W-2-020-LE-E-UO
- Diámetros disponibles:
 - Ø80/Ø100 - Ø100/Ø125

FLEXIBLE

Conductos FLEXIBLES para evacuación de humos de aparatos de condensación en instalaciones individuales en INTERIOR.

Características:

- Material:
 - PP corrugado.
- Espesor mínimo pared conducto: 1,5 mm.
- Combustible: Gas o Gasoil.
- Temperatura máxima: 120°C.
- Color: Blanco.
- Designación de producto:
 - T120-H1-W-2-020-LI-E-U
- Diámetros disponibles:
 - PP simple pared: Ø50 - Ø60 - Ø80 - Ø100 - Ø125 - Ø160 - Ø200
 - Coaxial: Ø60/100

COAXIAL

Conductos COAXIALES para sistemas de evacuación de humos de aparatos de condensación en instalaciones individuales en INTERIOR y tramos de unión en instalaciones COLECTIVAS.

Características:

- Material interior: PP.
- Material exterior: Acero lacado.
- Espesor pared interior: 1,5 mm (min).
- Combustible: Gas o Gasoil.
- Temperatura máxima: 120°C.
- Unión entre piezas: Machihembrada con junta de estanqueidad en interior y exterior.
- Color: Blanco.
- Junta: EPDM.
- Designación de producto:
 - T120-H1-W-2-0-00-LI-E-UO
- Diámetros disponibles:
 - Ø60/Ø100 - Ø80/Ø125 - Ø100/Ø150

Chimeplast®

Instalaciones individuales

SIMPLE PARED

Conductos y componentes para sistemas de EVACUACIÓN de humos de aparatos de condensación (caldera mural estanca de condensación) en instalaciones INDIVIDUALES y tramos de unión en instalaciones COLECTIVAS por INTERIOR. Estas instalaciones son en BIFLUJO (La admisión de aire y la extracción de humos de la caldera se realizan por dos tubos separados).

Características:

- Material:
 - Polipropileno (PP).
- Espesor mínimo pared conducto: 1,5 mm.
- Combustible: Gas o Gasoil.
- Temperatura máxima: 120°C.
- Juntas: EPDM.
- Colores:
 - Blanco.
- Designación de producto:
 - T120-H1-W-2-020-LI-E-U
- Diámetros disponibles:
 - Ø50 - Ø60 - Ø80 - Ø100



NOTA IMPORTANTE

Respetar inclinación mínima de 3° (5,2%) ascendente en instalaciones horizontales de conductos de evacuación de humos en polipropileno para aparatos a condensación.

(Norma EN 123001:2009, Apdo 5.5.1).

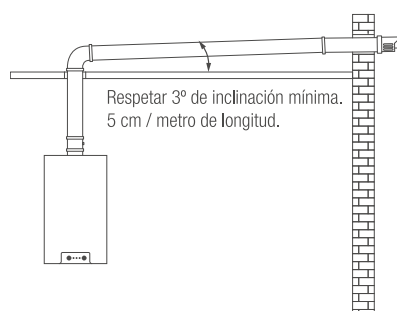

Los dibujos de las piezas son orientativos, FIG S.L. se reserva el derecho de cambiar las características de los productos sin previo aviso. Las dimensiones de las piezas son aproximadas, FIG S.L. no se hace responsable de problemas en la instalación de las mismas.



TERMINALES VERTICALES

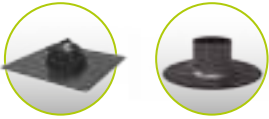

TERMINALES TEJAS



COMPLEMENTOS



AMPLIACIONES Y REDUCCIONES



INSPECCIONES



RECOGE CONDENSADOS



TUBOS Y CODOS



TERMINALES HORIZONTALES



ADAPTADORES BIFLUJO COMPATIBLES

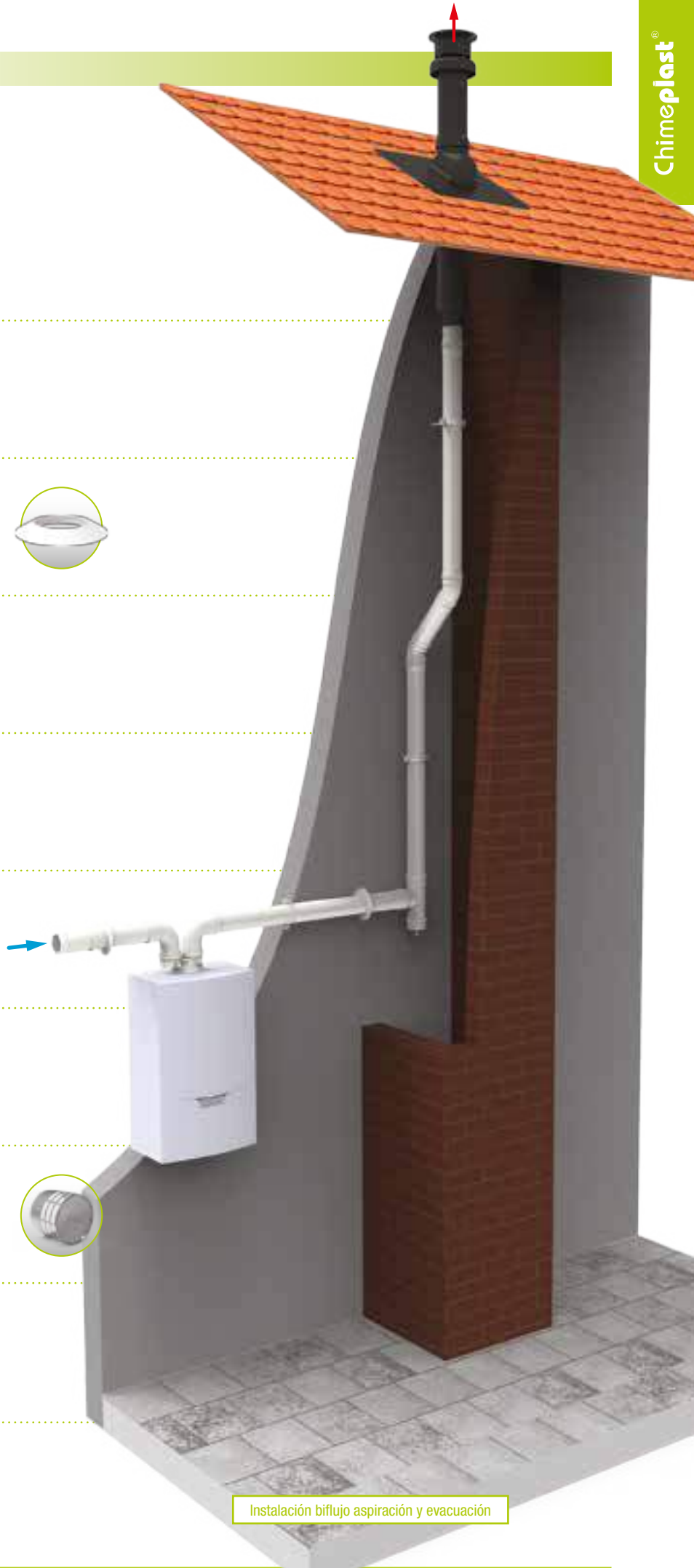

Instalación biflujo aspiración y evacuación

TUBOS

Tubo Macho - Hembra (PP)

Acabado

CÓDIGO	Ø	LONGITUD	€/UD
5-500MH5	Ø50	500 mm	7,74 €
5-1000MH5	Ø50	1000 mm	10,36 €
6-500MH5	Ø60	500 mm	9,59 €
6-1000MH5	Ø60	1000 mm	12,97 €
8-250MH5	Ø80	250 mm	6,56 €
8-500MH5	Ø80	500 mm	7,63 €
8-1000MH5	Ø80	1000 mm	10,62 €
8-2000MH5	Ø80	2000 mm	19,62 €
8-3000MH5	Ø80	3000 mm	28,80 €
10-500MH5	Ø100	500 mm	12,71 €
10-1000MH5	Ø100	1000 mm	17,49 €
10-2000MH5	Ø100	2000 mm	34,67 €

CODOS

Codo 90° Macho - Hembra (PP)

Acabado

CÓDIGO	Ø	€/UD
5-90MH5	Ø50	6,67 €
6-90MH5	Ø60	9,59 €
8-90MH5	Ø80	7,67 €
10-90MH5	Ø100	11,88 €

Codo 45° Macho - Hembra (PP)

Acabado

CÓDIGO	Ø	€/UD
5-45MH5	Ø50	7,14 €
6-45MH5	Ø60	9,27 €
8-45MH5	Ø80	7,14 €
10-45MH5	Ø100	11,34 €

RECOGE CONDENSADOS

Manguito con recoge condensados Macho - Hembra (PP)

Acabado

CÓDIGO	Ø	€/UD
8RCMH5	Ø80	37,06 €

Te con recogida de condensados Macho - Hembra (PP)

Acabado

CÓDIGO	Ø	€/UD
5TE5	Ø50	30,52 €
6TE5	Ø60	31,61 €
8TE5	Ø80	39,24 €
10TE5	Ø100	38,70 €

AMPLIACIONES Y REDUCCIONES

Ampliación Macho - Hembra (PP)



Acabado

CÓDIGO	Ø	€/UD
56AMPMH5	Ø50/60	26,16 €
58AMPMH5	Ø50/80	27,25 €
68AMPMH5	Ø60/80	10,29 €
810AMPMH5	Ø80/100	13,63 €
811AMPMH5	Ø80/110	32,17 €
8125AMPMH5	Ø80/125	39,89 €

Reducción Macho - Hembra (PP)



Acabado

CÓDIGO	Ø	€/UD
65REDMH5	Ø60/50	20,71 €
86REDMH5	Ø80/60	15,26 €
1080REDMH5	Ø100/80	14,51 €
1110REDMH5	Ø100/110	33,79 €

INSPECCIONES

Manguito con toma de muestras Macho - Hembra (PP)



Acabado

CÓDIGO	Ø	€/UD
6TM5	Ø60	16,29 €
8TM5	Ø80	17,11 €
10TM5	Ø100	21,36 €

Codo 90° con toma de muestras Macho - Hembra (PP)



Acabado

CÓDIGO	Ø	€/UD
8-90TM5	Ø80	19,30 €

Toma de muestras (EPDM negro)



Acabado

CÓDIGO	Ø	€/UD
TMEPDM		2,27 €

COMPLEMENTOS

Manguito Ø80 Hembra - Hembra (PP)



Acabado

CÓDIGO	Ø	€/UD
8MTT5	Ø80	13,65 €

Junta labiada (EPDM negro)



Acabado

CÓDIGO	Ø	€/UD
5JT6	Ø50	3,85 €
6JT6	Ø60	1,52 €
8JT6	Ø80	1,29 €
10JT6	Ø100	4,67 €

Plafón (EPDM blanco)



Acabado

CÓDIGO	Ø	€/UD
6PL6	Ø60	2,62 €
8PL6	Ø80	2,72 €
10PL6	Ø100	3,23 €
125PL6	Ø125	7,74 €

Anillo de seguridad (Acero)

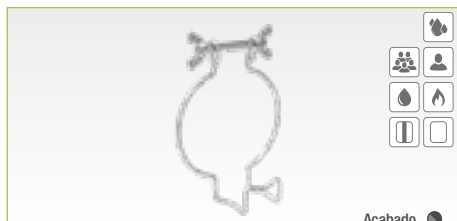

Acabado

CÓDIGO	Ø	€/UD
5ABSOPORTFLEX	Ø50	9,91 €
6ABSOPORTFLEX	Ø60	9,33 €
8ABSOPORTFLEX	Ø80	9,33 €
10ABSOPORTFLEX	Ø100	10,50 €

Abrazadera de pared (Acero lacado)



Acabado

CÓDIGO	Ø	€/UD
6ABPRP3	Ø60	5,67 €
8ABPRP3	Ø80	4,25 €
100ABPRP3	Ø100	4,08 €
125ABPRP3	Ø125	4,19 €

TERMINALES

Salida a techo (PP/PVC)



Acabado ●

CÓDIGO	Ø	€/UD
8ST58	Ø80	90,47 €
10ST58	Ø100	90,47 €

Terminal vertical corto (PP/PVC)



Acabado ●

CÓDIGO	Ø	€/UD
8DFV58	Ø80	26,16 €

Deflector evacuación salida cañón (Inox 304)



Acabado ○

CÓDIGO	Ø	€/UD
6DFHCA4	Ø60	6,32 €
8DFHCA4	Ø80	6,98 €

Deflector para aspiración horizontal (Nylon blanco)



Acabado ○

CÓDIGO	Ø	€/UD
8DFH7	Ø80	3,64 €

Deflector evacuación desviador de humos lateral regulable (PP/Inox)



Acabado ○

CÓDIGO	Ø	€/UD
8DFHRE4	Ø80	24,87 €

Deflector horizontal (Fibra)



Acabado ○

CÓDIGO	Ø	€/UD
8DFH5	Ø80	4,67 €

Deflector horizontal antulluvia exterior (PP negro)



Acabado ●

CÓDIGO	Ø	€/UD
6DFHALL5	Ø60	15,14 €
8DFHALL5	Ø80	15,77 €
10DFHALL5	Ø100	17,77 €

Deflector evacuación vertical (Inox)



Acabado ○

CÓDIGO	Ø	€/UD
6DFV4	Ø60	20,49 €
8DFV4	Ø80	17,88 €
10DFV4	Ø100	23,44 €

Deflector evacuación horizontal (Inox)



Acabado ○

CÓDIGO	Ø	€/UD
6DFH4	Ø60	8,18 €
8DFH4	Ø80	8,18 €
10DFH4	Ø100	14,17 €

Teja plana (PVC)



*Uso con 8ST58 y 10ST58
Acabado ●

CÓDIGO	Ø	€/UD
TEJAPLANAP1	Ø80 y Ø100	30,32 €

Teja* (PVC)



*Uso con 8ST58 y 10ST58
Acabado ●

CÓDIGO	Ø	€/UD
TEJA	Ø80 y Ø100	53,01 €

BOMBA DE CONDENSADOS

Bomba condensados



CÓDIGO	Ø	€/UD
BOMBA		198,27 €

Neutralizador de condensados



CÓDIGO	Ø	€/UD
NEUTRALIZADOR		64,38 €

Recambio de neutralizador



CÓDIGO	Ø	€/UD
RECAMBIONEUTRA		21,63 €

ADAPTADORES BIFLUJO COMPATIBLES

8ADBAT55



MARCA	MODELO	Ø	€/UD
ATLANTIC	T/M	Ø80	61,04 €

8ADBBEP15



MARCA	MODELO	Ø	€/UD
BERETTA	T/M	Ø80	70,76 €
MHG	Smartline	Ø80	

8ADBINTP15



MARCA	MODELO	Ø	€/UD
ACV	Kompact	Ø80	79,57 €
INTERGAS	T/M *(excepto HRE)	Ø80	

8ADBDOMP15



MARCA	MODELO	Ø	€/UD
DOMUSA	T/M	Ø80	48,63 €
FONDITAL	T/M	Ø80	
WOLF	CGB	Ø80	
	FGB	Ø80	

8ADBCH5



MARCA	MODELO	Ø	€/UD
DE DIETRICH	T/M	Ø80	52,98 €
ARISTON	T/M	Ø80	
CHAFFOTEAUX	T/M	Ø80	
THERMOR	T/M	Ø80	
SAUNIER DUVAL	GAMA MI	Ø80	

8ADBJK55



MARCA	MODELO	Ø	€/UD
JUNKERS	T/M	Ø80	81,75 €
VISSMANN	Vitodens 200 (45 y 60)	Ø80	
WOLF	CGB 35 y 50	Ø80	
REMEHA	Calenta	Ø80	
	Quinta Pro	Ø80	

8ADBSIDGTH255



MARCA	MODELO	Ø	€/UD
BIASI	T/M	Ø80	72,89 €
COINTRA	T/M	Ø80	
FAGOR	T/M	Ø80	
FERROLI	T/M	Ø80	
MANAUT	T/M	Ø80	
REMEHA	Avant	Ø80	
SIME	T/M	Ø80	
TIFELL	Ecomax	Ø80	

8ADBV15



MARCA	MODELO	Ø	€/UD
ACV	Prest. Solo MKIII 24-32	Ø80	74,12 €
BAXI	T/M	Ø80	
VISSMANN	Vitodens 50	Ø80	
	Vitodens 100	Ø80	
	Vitodens 111	Ø80	
	Vitodens 200 (25 y 35)	Ø80	

8ADBSDVAP15



MARCA	MODELO	Ø	€/UD
HERMANN	Micraplus Cond	Ø80	51,47 €
SAUNIER DUVAL	T/M (excepto GAMA MI)	Ø80	
VAILLANT	T/M	Ø80	

8MADBS15



MARCA	MODELO	Ø	€/UD
SIME	T/M	Ø80	46,87 €
COINTRA	T/M	Ø80	
BIASI	T/M	Ø80	
TIFELL	Ecomax	Ø80	

Kit con bomba de nebulización para calderas de condensación



CÓDIGO	€/UD
NUVOLACONDENS	224,70 €



- Fácil instalación / sin obras
- No se necesita desagüe
- Alcance de hasta 50 m. en horizontal y 5 m. en vertical
- Capacidad de evacuar 5 l/h

Chimeplast®

Instalaciones individuales

PROTEGIDO

Conductos y componentes para sistemas de EVACUACIÓN de humos de aparatos de condensación (caldera mural estanca de condensación) en instalaciones INDIVIDUALES y tramos de unión en instalaciones COLECTIVAS por EXTERIOR o PATINILLOS COMPARTIDOS.

Estas instalaciones son en BIFLUJO (La admisión de aire y la extracción de humos de la caldera se realizan por dos tubos separados).

Características:

- Material:
 - Polipropileno (PP) (interior)
 - Acero lacado (exterior y patinillos compartidos)
- Espesor mínimo pared conducto: 1,5 mm.
- Combustible: Gas o Gasoil.
- Temperatura máxima: 120°C.
- Juntas: EPDM.
- Colores:
 - Blanco (PP interior)
 - Blanco / Cobreado (Acero lacado).
- Designación de producto:
 - T120-H1-W-2-020-LE-E-UO
- Diámetros disponibles:
 - Ø80/100 - Ø100/125



NOTA IMPORTANTE

Respetar inclinación mínima de 3° (5,2%) ascendente en instalaciones horizontales de conductos de evacuación de humos en polipropileno para aparatos a condensación.

(Norma EN 123001:2009, Apdo 5.5.1).

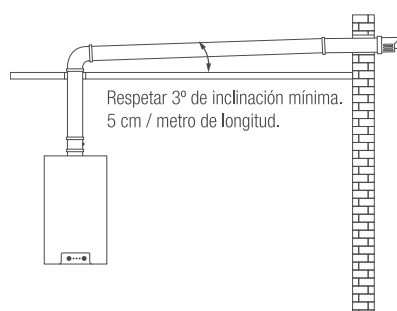

Los dibujos de las piezas son orientativos, FIG S.L. se reserva el derecho de cambiar las características de los productos sin previo aviso. Las dimensiones de las piezas son aproximadas, FIG S.L. no se hace responsable de problemas en la instalación de las mismas.



TERMINALES



ADAPTADORES



COMPLEMENTOS



RECOGE CONDENSADOS



TUBOS Y CODOS

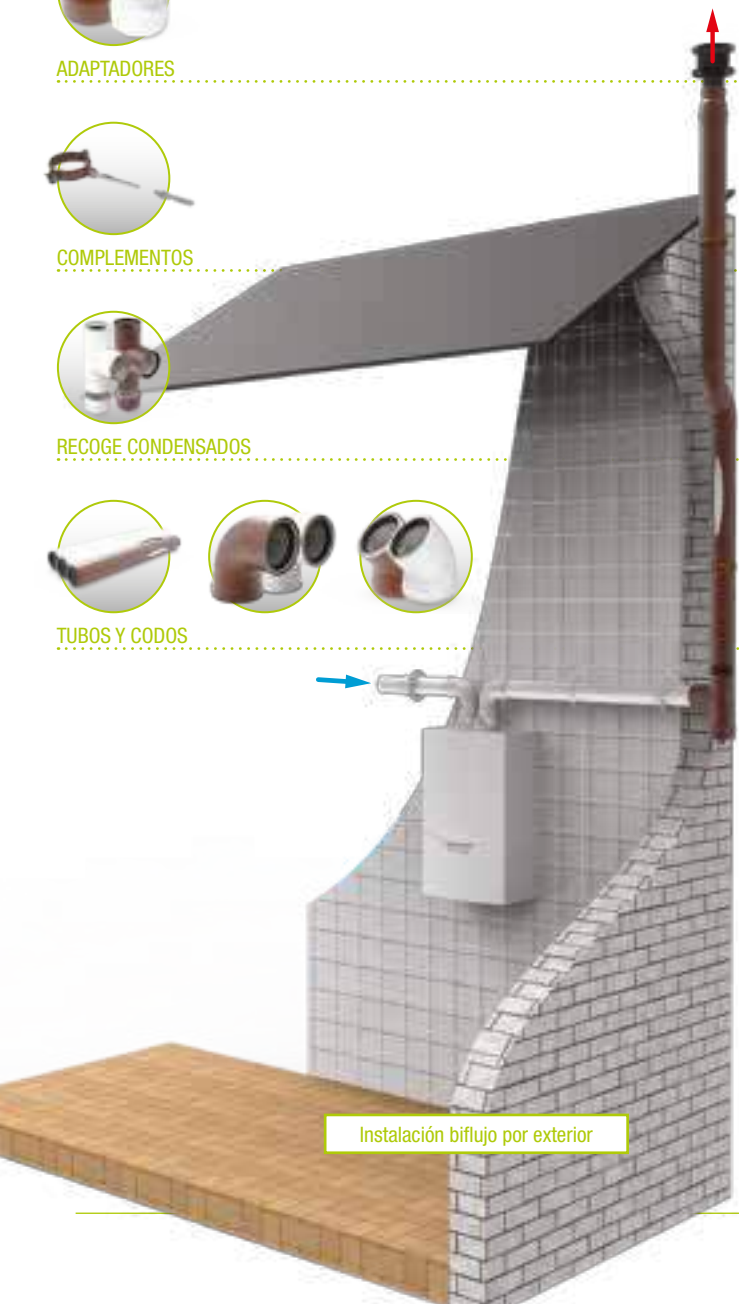

Instalación biflujo por exterior



Instalación biflujo por patinillo compartido

TUBOS

Tubo protegido Macho - Hembra (PP/Acero lacado)

Acabado

CÓDIGO	Ø	LONGITUD	€/UD
810-250MHP15	Ø80/100	250 mm	25,07 €
810-500MHP15	Ø80/100	500 mm	27,00 €
810-1000MHP15	Ø80/100	1000 mm	35,43 €
810-2000MHP15	Ø80/100	2000 mm	91,56 €
10125-250MHP15	Ø100/125	250 mm	31,07 €
10125-500MHP15	Ø100/125	500 mm	38,15 €
10125-1000MHP15	Ø100/125	1000 mm	45,78 €
10125-2000MHP15	Ø100/125	2000 mm	135,00 €
810-250MHP15-RA	Ø80/100	250 mm	28,75 €
810-500MHP15-RA	Ø80/100	500 mm	32,70 €
810-1000MHP15-RA	Ø80/100	1000 mm	40,33 €
810-2000MHP15-RA	Ø80/100	2000 mm	107,91 €
10125-250MHP15-RA	Ø100/125	250 mm	37,06 €
10125-500MHP15-RA	Ø100/125	500 mm	44,69 €
10125-1000MHP15-RA	Ø100/125	1000 mm	52,32 €
10125-2000MHP15-RA	Ø100/125	2000 mm	154,07 €

CODOS

Codo protegido 90° Macho - Hembra (PP/Acero lacado)

Acabado

CÓDIGO	Ø	€/UD
810-90MHP15	Ø80/100	28,34 €
10125-90MHP15	Ø100/125	38,88 €
810-90MHP15-RA	Ø80/100	32,70 €
10125-90MHP15-RA	Ø100/125	44,69 €

Codo protegido 45° Macho - Hembra (PP/Acero lacado)

Acabado

CÓDIGO	Ø	€/UD
810-45MHP15	Ø80/100	27,25 €
10125-45MHP15	Ø100/125	36,52 €
810-45MHP15-RA	Ø80/100	31,61 €
10125-45MHP15-RA	Ø100/125	42,51 €

RECOGE CONDENSADOS

Te con recogida de condensados protegida M - H (PP/Acero lacado)

Acabado

CÓDIGO	Ø	€/UD
810TEP15	Ø80/100	64,31 €
10125TEP15	Ø100/125	123,17 €
810TEP15-RA	Ø80/100	76,30 €
10125TEP15-RA	Ø100/125	140,61 €

ADAPTADORES

Adaptador de tubos protegidos a simple pared (PP/Acero lacado)



CÓDIGO	Ø	€/UD
810ADAP15	Ø80/100 a Ø80	21,80 €
10125ADAP15	Ø100/125 a Ø100	40,33 €
810ADAP15-RA	Ø80/100 a Ø80	26,16 €
10125ADAP15-RA	Ø100/125 a Ø100	46,87 €

Adaptador exterior de coaxial (Ø60/Ø100) a biflujo (Ø80) (PP/Acero lacado)



CÓDIGO	Ø	€/UD
610ENTRONASP15	Ø60/Ø100 a Ø80	28,34 €

COMPLEMENTOS

Abrazadera de pared (Acero lacado)



CÓDIGO	Ø	€/UD
10ABPRP3	Ø100	4,08 €
125ABPRP3	Ø125	4,19 €

Abrazadera de pared (Acero lacado)



CÓDIGO	Ø	€/UD
100ABPRP3-RA	Ø100	6,54 €
125ABPRP3-RA	Ø125	11,99 €

TERMINALES

Salida a techo (PP/PVC)



CÓDIGO	Ø	€/UD
810ST45	Ø80/100	66,49 €
10125ST45	Ø100/125	89,38 €

Chimeplast®

Instalaciones individuales

FLEXIBLE

Conductos FLEXIBLES para evacuación de humos de aparatos de condensación en instalaciones individuales en INTERIOR.

Características:

- Material:
 - PP corrugado.
- Espesor mínimo pared conducto: 1,5 mm.
- Combustible: Gas o Gasoil.
- Temperatura máxima: 120°C.
- Color: Blanco.
- Designación de producto:
 - T120-H1-W-2-020-LI-E-U
- Diámetros disponibles:
 - PP simple pared: Ø50 - Ø60 - Ø80 - Ø100 - Ø125 - Ø160 - Ø200
 - Coaxial: Ø60/100



NOTA IMPORTANTE

Respetar inclinación mínima de 30° en la instalación de conductos flexibles.

La conexión a caldera ha de hacerse con un tramo rígido EN NINGÚN CASO con conducto flexible.

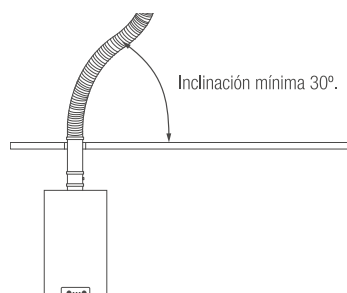

Los dibujos de las piezas son orientativos, FIG S.L. se reserva el derecho de cambiar las características de los productos sin previo aviso. Las dimensiones de las piezas son aproximadas, FIG S.L. no se hace responsable de problemas en la instalación de las mismas.



TERMINALES



MANGUITOS



COMPLEMENTOS

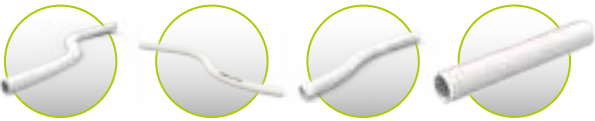

TUBOS



Renovación de instalación con flexible

TUBOS

Tubo flexible unión por manguitos (PP)

Acabado

CÓDIGO	Ø	LONGITUD	€/UD
5FLEXCONT5	Ø50	20 m	201,65 €
6FLEXCONT5	Ø60	20 m	212,27 €
8FLEXCONT5	Ø80	20 m	200,14 €
10FLEXCONT5	Ø100	20 m	363,89 €
125FLEXCONT5	Ø125	20 m	604,95 €
160FLEXCONT5	Ø160	20 m	730,30 €
200FLEXCONT5	Ø200	20 m	882,90 €

Kit manguitos unión tubo flexible (PP)

Acabado

CÓDIGO	Ø	€/UD
5UNIONFLEX5	Ø50	9,59 €
6UNIONFLEX5	Ø60	9,81 €
8UNIONFLEX5	Ø80	10,77 €
10UNIONFLEX5	Ø100	16,90 €
125UNIONFLEX5	Ø125	25,07 €
160UNIONFLEX5	Ø160	99,00 €
200UNIONFLEX5	Ø200	111,00 €

Tubo flexible recortable para aspiración (PP)

Acabado

CÓDIGO	Ø	LONGITUD	€/UD
8FLEXASPIRACION5	Ø80	25 m	262,65 €

Tubo flexible coaxial (PP)

Acabado

CÓDIGO	Ø	LONGITUD	€/UD
610-500FLEX5	Ø60/100	0,5 m	25,15 €
610-1000FLEX5	Ø60/100	1 m	44,94 €

Tubo flexible antibacteriano con el interior liso (Poliétileno)



*Uso exclusivo para ventilación

Acabado

CÓDIGO	Ø	LONGITUD	€/UD
75-50VENTOFLEX5	Ø75	50 m	274,08 €
90-50VENTOFLEX5	Ø90	50 m	384,88 €

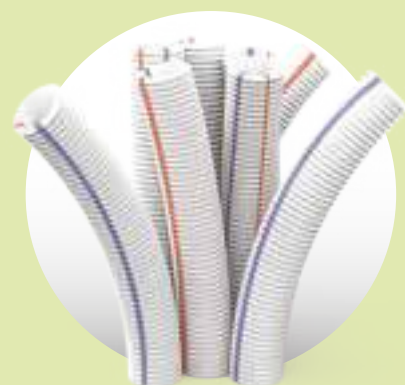

CARACTERÍSTICAS

Polietileno (PE)

Tubos lisos flexibles con el interior liso, realizados en polietileno (PE) y especialmente diseñados para conductos de sistemas de ventilación forzada.

Fácil instalación

Tubos flexibles de Ø75 y de Ø90 presentados en rollos de 50 m, fácil y rápido de cortar. Presenta además dos marcas de color que facilita y diferencia su instalación para aire frío o caliente.

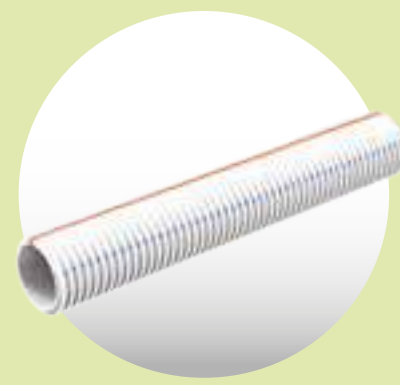

Tubo flexible para ventilación forzada

*Ideal para falsos techos*

Gracias al pequeño diámetro en el que se presentan estos tubos, unido a que son flexibles hacen de ellos el producto ideal para instalar en falsos techos de edificios y locales comerciales



COMPLEMENTOS

Centrador flexible (PP)



Acabado ●

CÓDIGO	Ø	€/UD
6CENTFLEX	Ø60	8,16 €
8CENTFLEX	Ø80	8,16 €
10CENTFLEX	Ø100	8,16 €
125CENTFLEX	Ø125	19,83 €
GRANCENTFLEX	Ø160-Ø200	19,83 €

Abrazadera de pared (Acero lacado)



Acabado ○

CÓDIGO	Ø	€/UD
6ABPRP3	Ø60	5,67 €
8ABPRP3	Ø80	4,25 €
10ABPRP3	Ø100	4,08 €
125ABPRP3	Ø125	4,19 €

Abrazadera de pared (Acero sin lacar)



Acabado ●

CÓDIGO	Ø	€/UD
160ABPRP3	Ø160	6,70 €
200ABPRP3	Ø200	7,21 €

Codo con soporte (PP)



Acabado ○

CÓDIGO	Ø	€/UD
8CODOSOPORTE5	Ø80	40,82 €

Te con soporte (PP)



Acabado ○

CÓDIGO	Ø	€/UD
8TESOPORTE5	Ø80	43,60 €

Junta labiada (EPDM negro)



CÓDIGO	Ø	€/UD
8JT6	Ø80	1,29 €

Anillo de seguridad (Acero)

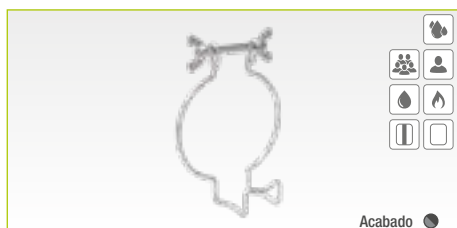

Acabado ●

CÓDIGO	Ø	€/UD
5ABSOPORTFLEX	Ø50	9,91 €
6ABSOPORTFLEX	Ø60	9,33 €
8ABSOPORTFLEX	Ø80	9,33 €
10ABSOPORTFLEX	Ø100	10,50 €
125ABSOPORTFLEX	Ø125	12,54 €
160ABSOPORTFLEX	Ø160	22,89 €
200ABSOPORTFLEX	Ø200	30,52 €

TERMINALES

Terminal teja plana (aspiración / evacuación) (PP/PVC)



Acabado ●

CÓDIGO	Ø	€/UD
5COPPO5	Ø50	117,66 €
6COPPO5	Ø60	89,76 €
8COPPO5	Ø80	87,67 €
10COPPO5	Ø100	100,68 €
125COPPO5	Ø125	111,59 €

Chimeplast®

Instalaciones individuales

COAXIAL

Conductos COAXIALES para sistemas de evacuación de humos de aparatos de condensación en instalaciones individuales en INTERIOR y tramos de unión en instalaciones COLECTIVAS.

Características.

- Material interior: PP.
- Material exterior: Acero lacado.
- Espesor pared interior: 1,5 mm (min).
- Combustible: Gas o Gasoil.
- Temperatura máxima: 120°C.
- Unión entre piezas: Machihembra con junta de estanqueidad en interior y exterior.
- Color: Blanco.
- Junta: EPDM.
- Designación de producto:
 - T120-H1-W-2-0-00-LI-E-UO
- Diámetros disponibles:
 - Ø60/Ø100 - Ø80/Ø125 - Ø100/Ø150



NOTA IMPORTANTE

Respetar inclinación mínima de 3° (5,2%) ascendente en instalaciones horizontales de conductos de evacuación de humos en polipropileno para aparatos a condensación.

(Norma EN 123001:2009, Apdo 5.5.1).

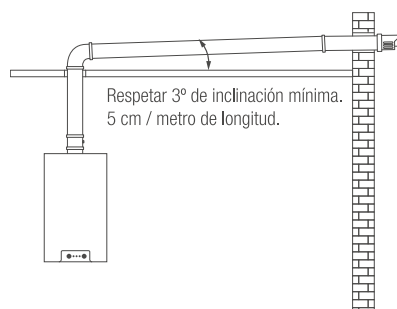

Los dibujos de las piezas son orientativos, FIG S.L. se reserva el derecho de cambiar las características de los productos sin previo aviso. Las dimensiones de las piezas son aproximadas, FIG S.L. no se hace responsable de problemas en la instalación de las mismas.



TERMINALES

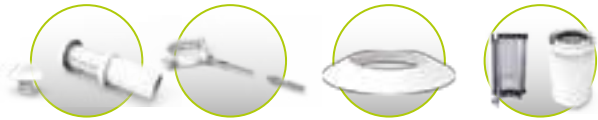

COMPLEMENTOS



RECIBE CONDENSADOS E INSPECCIONES



CONEXIONES VERTICALES Y KITS HORIZONTALES



AMPLIACIONES Y ADAPTADORES



TUBOS Y CODOS



Instalación coaxial de evacuación y aspiración

TUBOS

Tubo coaxial Macho - Hembra (PP/Acero lacado)



	CÓDIGO	Ø	LONGITUD	€/UD
Ø60/Ø100	610-250MHP15	Ø60/Ø100	250	14,80 €
	610-500MHP15	Ø60/Ø100	500	17,32 €
	610-1000MHP15	Ø60/Ø100	1000	23,47 €
	610-1500MHP15	Ø60/Ø100	1500	61,20 €
	610-2000MHP15	Ø60/Ø100	2000	63,27 €
Ø80/Ø125	8125-250MHP15	Ø80/Ø125	250	21,26 €
	8125-500MHP15	Ø80/Ø125	500	25,07 €
	8125-1000MHP15	Ø80/Ø125	1000	33,25 €
	8125-2000MHP15	Ø80/Ø125	2000	90,63 €
Ø100/Ø150	10150-250MHP15	Ø100/Ø150	250	32,70 €
	10150-500MHP15	Ø100/Ø150	500	39,24 €
	10150-1000MHP15	Ø100/Ø150	1000	50,14 €

CODOS

Codo 90° coaxial Macho - Hembra (PP/Acero lacado)



CÓDIGO	Ø	€/UD
610-90MHP15	Ø60/Ø100	23,08 €
8125-90MHP15	Ø80/Ø125	41,17 €
10150-90MHP15	Ø100/Ø150	51,72 €

Codo 45° coaxial Macho - Hembra (PP/Acero lacado)



CÓDIGO	Ø	€/UD
610-45MHP15	Ø60/Ø100	23,51 €
8125-45MHP15	Ø80/Ø125	38,21 €
10150-45MHP15	Ø100/Ø150	49,05 €

Codo 90° asimétrico coaxial Macho - Hembra (PP/Acero lacado)



CÓDIGO	Ø	€/UD
610-90ASIMHP15	Ø60/Ø100	65,40 €

RECOGE CONDENSADOS

Te coaxial con recogida de condensados M - H (PP/Acero lacado)



CÓDIGO	Ø	€/UD
610TEP15	Ø60/Ø100	57,77 €
8125TEP15	Ø80/Ø125	83,93 €
10150TEP15	Ø100/Ø150	185,30 €

Tramo coaxial con recogida de condensados M - H (PP/Acero lacado)



CÓDIGO	Ø	€/UD
610RCMHP15	Ø60/Ø100	71,94 €
8125RCMHP15	Ø80/Ø125	94,83 €

AMPLIACIONES, REDUCCIONES Y ADAPTADORES

Ampliación coaxial Macho - Hembra (PP/Acero lacado)



Acabado

CÓDIGO	Ø	€/UD
6810125AMPMHP15	Ø60/Ø100 A Ø80/Ø125	25,73 €
812510150AMPMHP15	Ø80/Ø125 A Ø100/Ø150	80,00 €

Reducción coaxial Macho - Hembra (PP/Acero lacado)



Acabado

CÓDIGO	Ø	€/UD
110160100150RED5	Ø110/Ø160 a Ø100/Ø150	95,79 €

Adaptador exterior de coaxial (Ø60/Ø100) a biflujo (Ø80) (PP/Acero lacado)



Acabado

CÓDIGO	Ø	€/UD
610ENTRONASP15	Ø60/Ø100 a Ø80	28,34 €

Adaptador biflujo (Ø80/Ø80) a coaxial (Ø80/Ø125) (PP/Acero lacado)



Acabado

CÓDIGO	Ø	€/UD
80808125ADAP5	Ø80/Ø80 a Ø80/Ø125	45,78 €

INSPECCIONES

Tramo coaxial con toma de muestras Macho - Hembra (PP/Acero lacado)



Acabado

CÓDIGO	Ø	€/UD
610TMMHP15	Ø60/Ø100	34,99 €
8125TMMHP15	Ø80/Ø125	58,22 €
10150TMMHP15	Ø100/Ø150	89,88 €

Codo 90° coaxial con inspección Macho - Hembra (PP/Acero lacado)



Acabado

CÓDIGO	Ø	€/UD
610-90IVP15	Ø60/Ø100	70,00 €
8125-90IVP15	Ø80/Ø125	100,00 €
10150-90IVP15	Ø100/Ø150	98,10 €

Tramo coaxial con inspección Macho - Hembra (PP/Acero lacado)



Acabado

CÓDIGO	Ø	€/UD
610IVP15	Ø60/Ø100	68,00 €
8125IVP15	Ø80/Ø125	95,00 €
10150IVP15	Ø100/Ø150	185,30 €

Kit toma de muestras



Acabado

CÓDIGO	Ø	€/UD
610KITTMP15		19,57 €

Broca para realizar toma de muestras



Acabado

CÓDIGO	Ø	€/UD
CORONA16		33,27 €

COMPLEMENTOS

Manguito coaxial Hembra - Hembra (PP/Acero lacado)



Acabado

CÓDIGO	Ø	€/UD
610MTTP15	Ø60/Ø100	29,54 €

Abrazadera de pared (Acero lacado)



Acabado

CÓDIGO	Ø	€/UD
10ABPRP3	Ø100	4,08 €
125ABPRP3	Ø125	4,19 €

Abrazadera de pared (Acero sin lacar)



Acabado

CÓDIGO	Ø	€/UD
150ABPRP3	Ø150	6,18 €



610MTTP15

Manguito coaxial Hembra - Hembra



610MTTP15

PASO 1
Detectar fuga o tramo cortado

PASO 4
Conectar el tubo exterior de aluminio de Ø100

PASO 2
En caso de ser necesario cortar el tubo

PASO 3
Introducir el manguito. Conectar primero el tubo de Ø60 de PP

610-90ASIMHP15 Codo 90° asimétrico coaxial Macho - Hembra

Es el accesorio imprescindible para salvar esquinas fácilmente en instalaciones de evacuación de humos ya que se adaptan a instalaciones antiguas en renovaciones de calderas.



Plafón (EPDM blanco)



CÓDIGO	Ø	€/UD
10PL6	Ø100	3,23 €
125PL6	Ø125	7,74 €

TERMINALES

Terminal coaxial horizontal (terminal + plafones EPDM) (PP/Acero lacado)



*Instalar sin inclinación

Acabado

CÓDIGO	Ø	€/UD
610TDFHP15	Ø60/Ø100	49,49 €
8125TDFHP15	Ø80/Ø125	57,90 €

Terminal coaxial horizontal orientable (PP/Acero lacado)



90°

*Instalar sin inclinación

Acabado

CÓDIGO	Ø	€/UD
610TDFHORIENP15	Ø60/Ø100	49,49 €

Terminal coaxial horizontal (sólo tubo terminal) (PP/Acero lacado)



*Instalar sin inclinación

Acabado

CÓDIGO	Ø	€/UD
10150TDFHP15	Ø100/Ø150	112,27 €

Terminal horizontal coaxial corto (PP/Acero lacado/Nylon blanco)



Acabado

CÓDIGO	Ø	€/UD
610TDFHC57	Ø60/Ø100	29,97 €
8125TDFHC57	Ø80/Ø125	28,89 €

Terminal horizontal coaxial corto (PP/Acero lacado/Nylon negro)



Acabado

CÓDIGO	Ø	€/UD
610TDFHC57N	Ø60/Ø100	29,97 €

Accesorio desvío humos para terminal (PP)



*Terminal NO INCLUIDO

Acabado

CÓDIGO	Ø	€/UD
610DFORIENT5	Ø60/Ø100	18,92 €

Salida a techo coaxial (PP/PVC)



Acabado

CÓDIGO	Ø	€/UD
610ST58	Ø60/Ø100	88,78 €
8125ST58	Ø80/Ø125	91,36 €

Salida a techo coaxial anti-hielo (no frost) (PP/PVC)



Acabado

CÓDIGO	Ø	€/UD
610STNF58	Ø60/Ø100	89,76 €
8125STNF58	Ø80/Ø125	95,82 €

Terminal vertical coaxial corto (PP/PVC)



Acabado

CÓDIGO	Ø	€/UD
610DFV58	Ø60/Ø100	44,69 €
8125DFV58	Ø80/Ø125	64,31 €

Salida a techo coaxial (PP/PVC)



Acabado

CÓDIGO	Ø	€/UD
10150ST58	Ø100/Ø150	152,60 €

Teja plana (PVC)



*Uso con 610ST58, 8125ST58, 610STNF58 y 8125STNF58

Acabado

CÓDIGO	Ø	€/UD
TEJAPLANAP1	Ø60/Ø100 y Ø80/Ø125	30,32 €

Teja* (PVC)



*Uso con 610ST58, 8125ST58, 610STNF58 y 8125STNF58

Acabado

CÓDIGO	Ø	€/UD
TEJA	Ø60/Ø100 y Ø80/Ø125	53,01 €

KITS HORIZONTALES COMPATIBLES

610KCCSIP15 (PP/Acero lacado)



Acabado

MARCA	MODELO	Ø	€/UD
BIASI	T/M	Ø60/Ø100	54,58 €
COINTRA	T/M	Ø60/Ø100	
FAGOR	T/M	Ø60/Ø100	
FERROLI	T/M	Ø60/Ø100	
MANAUT	T/M	Ø60/Ø100	
REMEHA	Avant	Ø60/Ø100	
TIFELL	Ecomax	Ø60/Ø100	

610KCCVIP15 (PP/Acero lacado)



Acabado

MARCA	MODELO	Ø	€/UD
ACV	Prest. Solo MKII 24-32	Ø60/Ø100	59,39 €
BAXI	T/M	Ø60/Ø100	
DE DIETRICH	T/M	Ø60/Ø100	
VIESSMANN	Vitodens 050	Ø60/Ø100	
	Vitodens 100	Ø60/Ø100	
	Vitodens 111	Ø60/Ø100	
	Vitodens 200 (25 y 35)	Ø60/Ø100	

610KCCDOMP15 (PP/Acero lacado)



Acabado

MARCA	MODELO	Ø	€/UD
DOMUSA	T/M	Ø60/Ø100	59,50 €
FONDITAL	T/M	Ø60/Ø100	
WOLF	CGB	Ø60/Ø100	
	FGB	Ø60/Ø100	

610KCCJKP15 (PP/Acero lacado)



Acabado

MARCA	MODELO	Ø	€/UD
JUNKERS	T/M	Ø60/Ø100	66,71 €

610KCCIMMP15 (PP/Acero lacado)



Acabado

MARCA	MODELO	Ø	€/UD
IMMERGAS	T/M	Ø60/Ø100	97,85 €

610KCCAT55 (PP)



Acabado

MARCA	MODELO	Ø	€/UD
ATLANTIC	T/M	Ø60/Ø100	58,22 €

610KCCCHP15 (PP/Acero lacado)



Acabado

MARCA	MODELO	Ø	€/UD
ARISTON	T/M	Ø60/Ø100	68,92 €
CHAFFOATEAUX	T/M	Ø60/Ø100	
THERMOR	T/M	Ø60/Ø100	

610KCCSDVAP15 (PP/Acero lacado)



Acabado

MARCA	MODELO	Ø	€/UD
HERMANN	Micraplus Cond.	Ø60/Ø100	66,71 €
VAILLANT	T/M	Ø60/Ø100	
SAUNIER DUVAL	T/M	Ø60/Ø100	

610KCCINT55 (PP)



Acabado

MARCA	MODELO	Ø	€/UD
ACV	Kompact	Ø60/Ø100	73,35 €
INTERGAS	T/M excepto HRE	Ø60/Ø100	

610KCCBEP15 (PP/Acero lacado)



Acabado

MARCA	MODELO	Ø	€/UD
BERETTA	T/M	Ø60/Ø100	59,95 €
MHG	Smartline	Ø60/Ø100	

KIT REPO (PP/Acero lacado)



Acabado

CÓDIGO	Ø	€/UD
610KCCSUST55	Ø60/Ø100	54,58 €



Los KITS han de instalarse horizontales, sin inclinación.

SALIDAS VERTICALES COMPATIBLES

610CVSIP15 (PP/Acero lacado)



Acabado 

MARCA	MODELO	Ø	€/UD
BIASI	T/M	Ø60/Ø100	49,49 €
COINTRA	T/M	Ø60/Ø100	
FAGOR	T/M	Ø60/Ø100	
FERROLI	T/M	Ø60/Ø100	
MANAUT	T/M	Ø60/Ø100	
SIME	T/M	Ø60/Ø100	
TIFELL	Ecomax	Ø60/Ø100	

610CVCHP15 (PP/Acero lacado)



Acabado 

MARCA	MODELO	Ø	€/UD
ARISTON	T/M	Ø60/Ø100	51,47 €
CHAFFOTEAUX	T/M	Ø60/Ø100	
THERMOR	T/M	Ø60/Ø100	
SAUNIER DUVAL	GAMA MI	Ø60/Ø100	

610CVDOMP15 (PP/Acero lacado)



Acabado 

MARCA	MODELO	Ø	€/UD
DOMUSA	T/M	Ø60/Ø100	47,69 €
FONDITAL	T/M	Ø60/Ø100	
WOLF	CGB	Ø60/Ø100	
	FGB	Ø60/Ø100	

610CVSDVAP15 (PP/Acero lacado)



Acabado 

MARCA	MODELO	Ø	€/UD
HERMANN	Micraplus Cond	Ø60/Ø100	60,65 €
SAUNIER DUVAL	T/M (excepto GAMA MI)	Ø60/Ø100	
VAILLANT	T/M	Ø60/Ø100	

610CVVIP15 (PP/Acero lacado)



Acabado 

MARCA	MODELO	Ø	€/UD
BAXI	T/M	Ø60/Ø100	49,49 €

610CVJKP15 (PP/Acero lacado)



Acabado 

MARCA	MODELO	Ø	€/UD
JUNKERS	T/M	Ø60/Ø100	51,47 €

610CVINTP15 (PP/Acero lacado)



Acabado 

MARCA	MODELO	Ø	€/UD
ACV	Kompact	Ø60/Ø100	59,95 €
INTERGAS	T/M exc. HRE	Ø60/Ø100	

610CVBEP15 (PP/Acero lacado)



Acabado 

MARCA	MODELO	Ø	€/UD
BERETTA	T/M	Ø60/Ø100	49,49 €
MHG	Smartline	Ø60/Ø100	

610CVAT55 (PP/Acero lacado)



Acabado 

MARCA	MODELO	Ø	€/UD
ATLANTIC	T/M	Ø60/Ø100	49,49 €

610VIMMP15 (PP/Acero lacado)



Acabado 

MARCA	MODELO	Ø	€/UD
IMMERSAS	T/M	Ø60/Ø100	56,35 €

8125CVJKP15 (PP/Acero lacado)



*Para tubos Ø80/Ø125
Acabado 

MARCA	MODELO	Ø	€/UD
JUNKERS	T/M	Ø80/Ø125	51,47 €

8125CVSDVAP15 (PP/Acero lacado)



*Para tubos Ø80/Ø125
Acabado 

MARCA	MODELO	Ø	€/UD
SAUNIER DUVAL	T/M (excepto GAMA MI)	Ø80/Ø125	51,47 €
VAILLANT	T/M	Ø80/Ø125	

Chimeplast[®]

Instalaciones individuales y
colectivas de alta potencia

CONDUCTOS Y COMPONENTES PARA APARATOS DE CONDENSACIÓN EN
INSTALACIONES INDIVIDUALES Y COLECTIVAS

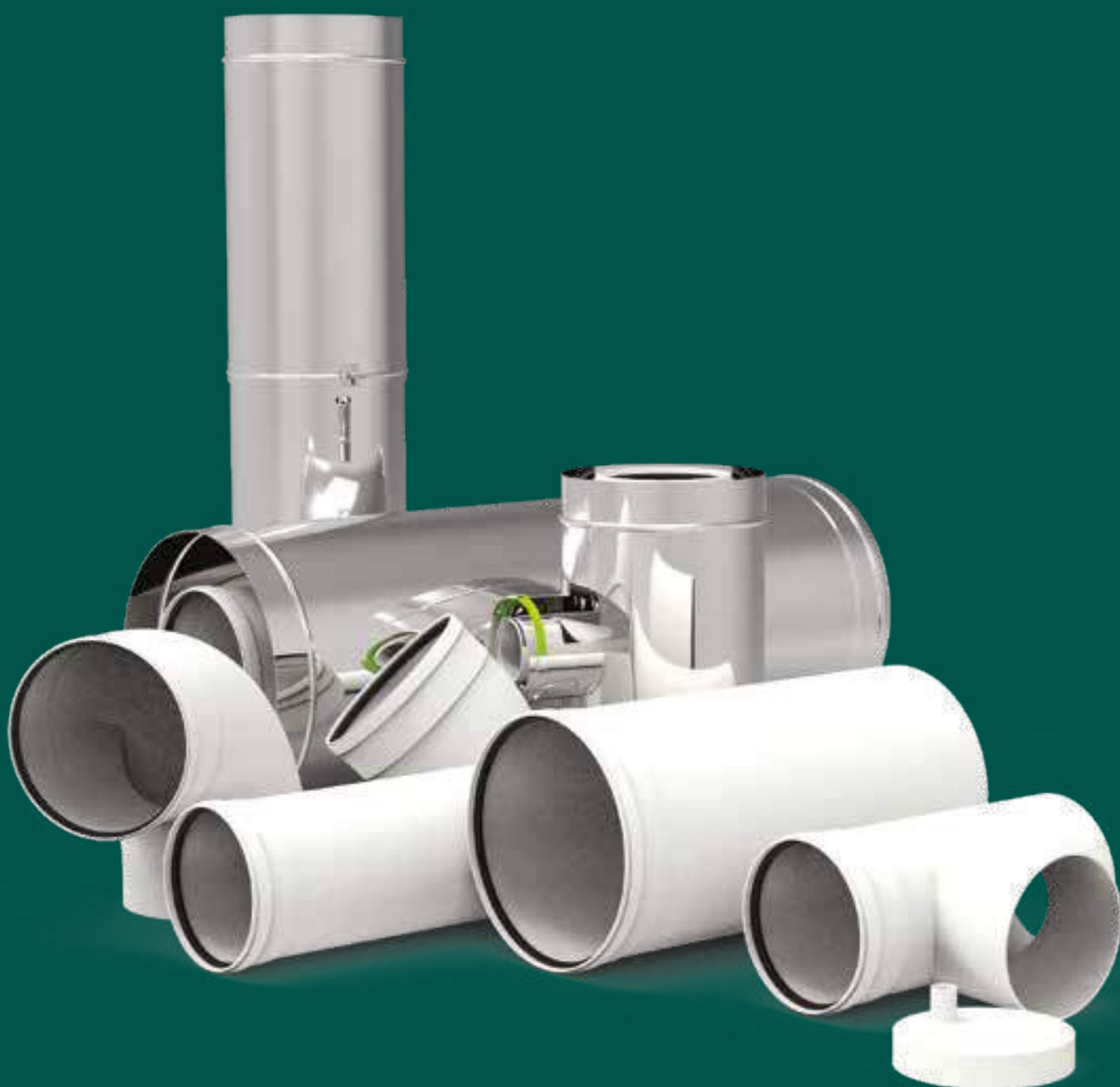

SIMPLE PARED

Conductos para evacuación de humos de aparatos de condensación en instalaciones COLECTIVAS verticales y horizontales, en biflujo o en cascada, para calderas de gran potencia en INTERIOR.

Características:

- Espesor mínimo pared interior: 2,2 mm.
- Combustible: Gas o Gasoil.
- Temperatura máxima: 120°C.
- Color: Blanco.
- Unión entre piezas: Machihembrada.
- Junta de estanqueidad: EPDM.
- Designación de producto:
 - ø110, ø125, ø160: T120-H1-W-2-0-20-LI-E-U
 - ø200, ø250, ø300: T120-P1-W-2-0-20-LI-E-U
- Diámetros disponibles:
 - ø110 - ø125 - ø160 - ø200 - ø250 - ø300

PROTEGIDO

Conductos para evacuación de humos de aparatos de condensación en instalaciones colectivas verticales y horizontales, y calderas de gran potencia en EXTERIOR o patinillos compartidos.

Características:

- Material interior: Polipropileno.
- Material exterior: Acero inoxidable AISI 304 o AISI 316 (ver descripciones).
- Espesor mínimo pared interior: 2,2 mm.
- Combustible Gas o Gasoil.
- Unión entre piezas: Machihembrada.
- Junta estanqueidad: EPDM.
- Temperatura máxima 120°C.
- Color Inox.
- Designación de producto:
 - ø125, ø160: T120-H1-W-2-000-LE-E-U0
 - ø200, ø250, ø300: T120-P1-W-2-000-LE-E-U0
- Diámetros disponibles:
 - ø125/ø150 - ø160/ø180 - ø200/ø250 - ø250/ø300 - ø300/ø350

COAXIAL

Conductos para evacuación de humos y aspiración de aire de combustión, de aparatos de condensación en instalaciones colectivas verticales y calderas de gran potencia en EXTERIOR o patinillos compartidos.

Características:

- Material interior: Polipropileno.
- Material exterior: Acero inoxidable AISI 304 o AISI 316 (ver descripciones).
- Espesor mínimo pared interior: 2,2 mm.
- Combustible Gas o Gasoil.
- Unión entre piezas: Machihembrada.
- Junta estanqueidad: EPDM.
- Temperatura máxima 120°C.
- Color Inox.
- Designación de producto:
 - ø125, ø160: T120-H1-W-2-000-LE-E-U0
 - ø200, ø250, ø300: T120-P1-W-2-000-LE-E-U0
- Diámetros disponibles:
 - ø125/ø200 - ø160/ø250 - ø200/ø350 - ø250/ø400 - ø300/ø450

Chimeplast®

Instalaciones individuales y colectivas de alta potencia

SIMPLE PARED

Conductos para evacuación de humos de aparatos de condensación en instalaciones COLECTIVAS verticales y horizontales, en biflujo o en cascada, para calderas de gran potencia en INTERIOR.

Características:

- Espesor mínimo pared interior: 2,2 mm.
- Combustible: Gas o Gasoil.
- Temperatura máxima: 120°C.
- Color: Blanco.
- Unión entre piezas: Machihembrada.
- Junta de estanqueidad: EPDM.
- Designación de producto:
 - \varnothing 110, \varnothing 125, \varnothing 160: T120-H1-W-2-0-20-LI-E-U
 - \varnothing 200, \varnothing 250, \varnothing 300: T120-P1-W-2-0-20-LI-E-U
- Diámetros disponibles:
 - \varnothing 110 - \varnothing 125 - \varnothing 160 - \varnothing 200 - \varnothing 250 - \varnothing 300



NOTA IMPORTANTE

Respetar inclinación mínima de 3° (5,2%) ascendente en instalaciones horizontales de conductos de evacuación de humos en polipropileno para aparatos a condensación.

(Norma EN 123001:2009, Apdo 5.5.1).

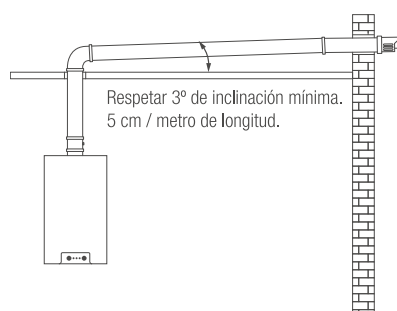

Los dibujos de las piezas son orientativos, FIG S.L. se reserva el derecho de cambiar las características de los productos sin previo aviso.

Las dimensiones de las piezas son aproximadas, FIG S.L. no se hace responsable de problemas en la instalación de las mismas.



TERMINALES



COMPLEMENTOS



COLECTORES HORIZONTALES



COLECTORES VERTICALES



RECOGE CONDENSADOS



AMPLIACIONES



TUBOS Y CODOS



VÁLVULAS



Instalación de evacuación por patinillo

TUBOS

Tubo Macho - Hembra (PP)

Acabado

CÓDIGO	Ø	LONGITUD	€/UD
11-500MH5	Ø110	500	15,75 €
11-1000MH5	Ø110	1000	18,64 €
11-2000MH5	Ø110	2000	38,72 €
125-500MH5	Ø125	500	17,66 €
125-1000MH5	Ø125	1000	31,54 €
125-2000MH5	Ø125	2000	46,65 €
160-500MH5	Ø160	500	29,43 €
160-1000MH5	Ø160	1000	46,65 €
160-2000MH5	Ø160	2000	71,90 €
200-500MH5	Ø200	500	47,96 €
200-1000MH5	Ø200	1000	58,86 €
200-2000MH5	Ø200	2000	113,13 €
250-500MH5	Ø250	500	103,55 €
250-1000MH5	Ø250	1000	98,10 €
250-2000MH5	Ø250	2000	166,78 €
300-500MH5	Ø300	500	119,90 €
300-1000MH5	Ø300	1000	95,64 €
300-2000MH5	Ø300	2000	291,58 €

CODOS

Codo 90° Macho - Hembra (PP)

Acabado

CÓDIGO	Ø	€/UD
11-90MH5	Ø110	15,26 €
125-90MH5	Ø125	21,26 €
160-90MH5	Ø160	37,84 €
200-90MH5	Ø200	50,46 €
250-90MH5	Ø250	119,90 €
300-90MH5	Ø300	154,78 €

Codo 45° Macho - Hembra (PP)

Acabado

CÓDIGO	Ø	€/UD
11-45MH5	Ø110	15,26 €
125-45MH5	Ø125	18,92 €
160-45MH5	Ø160	29,01 €
200-45MH5	Ø200	44,15 €
250-45MH5	Ø250	90,47 €
300-45MH5	Ø300	119,90 €

RECUGE CONDENSADOS

Te con recogida de condensados (PP)

Acabado

CÓDIGO	Ø	€/UD
11TE5	Ø110	57,01 €
125TE5	Ø125	58,22 €
160TE5	Ø160	86,11 €
200TE5	Ø200	93,74 €
250TE5	Ø250	160,23 €
300TE5	Ø300	223,45 €

Tape desagüe condensados vertical (PP)

Acabado

CÓDIGO	Ø	€/UD
125TAPE5	Ø125	23,98 €
160TAPE5	Ø160	30,52 €
200TAPE5	Ø200	38,15 €
250TAPE5	Ø250	42,51 €
300TAPE5	Ø300	50,15 €

Tape desagüe condensados instalación horizontal (PP)

Acabado

CÓDIGO	Ø	€/UD
125TAPECONDENSA	Ø125	25,66 €
160TAPECONDENSA	Ø160	30,88 €
200TAPECONDENSA	Ø200	38,49 €
250TAPECONDENSA	Ø250	42,46 €
300TAPECONDENSA	Ø300	51,23 €

COLECTORES VERTICALES

Colector vertical 90° entronque Ø80 (PP)



CÓDIGO	Ø	€/UD
8125COLVERT5	Ø125	42,53 €
8160COLVERT5	Ø160	55,96 €
8200COLVERT5	Ø200	73,82 €
8250COLVERT5	Ø250	112,35 €
8300COLVERT5	Ø300	123,05 €

Colector vertical 90° entronque Ø80 con válvula antirretorno (PP)



CÓDIGO	Ø	€/UD
125COLVERTPPOS5	Ø125	72,76 €
160COLVERTPPOS5	Ø160	104,86 €
200COLVERTPPOS5	Ø200	130,02 €
250COLVERTPPOS5	Ø250	158,36 €
300COLVERTPPOS5	Ø300	192,60 €

Colector vertical doble entrada con válvulas entronque Ø80 (PP)



CÓDIGO	Ø	€/UD
8125DOBCOLVERT5	Ø125	128,10 €
8160DOBCOLVERT5	Ø160	143,10 €
8200DOBCOLVERT5	Ø200	160,74 €
8250DOBCOLVERT5	Ø250	214,00 €
8300DOBCOLVERT5	Ø300	235,40 €

COLECTORES HORIZONTALES

Colector horizontal entronque 90° inferior (PP)



CÓDIGO	Ø	ØENT	€/UD
100125COLDIREC5	Ø125	Ø100	70,35 €
100160COLDIREC5	Ø160	Ø100	87,15 €
100200COLDIREC5	Ø200	Ø100	98,44 €
100250COLDIREC5	Ø250	Ø100	136,25 €
100300COLDIREC5	Ø300	Ø100	133,75 €
160200COLDIREC5	Ø200	Ø160	115,56 €
160250COLDIREC5	Ø250	Ø160	156,60 €
160300COLDIREC5	Ø300	Ø160	177,46 €

Colector horizontal entronque 45° válido izquierda y derecha codo 90° (PP)



CÓDIGO	Ø	ØENT	€/UD
100125LONGCOL5	Ø125	Ø100	86,10 €
100160LONGCOL5	Ø160	Ø100	110,25 €
100200LONGCOL5	Ø200	Ø100	121,90 €
100250LONGCOL5	Ø250	Ø100	155,15 €
100300LONGCOL5	Ø300	Ø100	160,50 €
160200LONGCOL5	Ø200	Ø160	160,74 €
160250LONGCOL5	Ø250	Ø160	198,38 €
160300LONGCOL5	Ø300	Ø160	200,36 €

Colector horizontal doble entronque 45° codos a 90° (PP)



CÓDIGO	Ø	ØENT	€/UD
100125DOBLECOL5	Ø125	Ø100	123,90 €
100160DOBLECOL5	Ø160	Ø100	141,75 €
100200DOBLECOL5	Ø200	Ø100	148,40 €
100250DOBLECOL5	Ø250	Ø100	198,13 €
100300DOBLECOL5	Ø300	Ø100	214,00 €

AMPLIACIONES

Adaptador caldera / Ampliación (PP)



CÓDIGO	Ø	€/UD
1011AMPMH5	Ø100/110	34,74 €
10125AMPMH5	Ø100/125	37,84 €
11125AMPMH5	Ø110/125	41,63 €
125160AMPMH5	Ø125/160	58,03 €
130160AMPMH5	Ø130/160	80,25 €
150160AMPMH5	Ø150/160	80,25 €
160200AMPMH5	Ø160/200	72,06 €
180200AMPMH5	Ø180/200	87,74 €
200250AMPMH5	Ø200/250	100,92 €
225250AMPMH5	Ø225/250	136,93 €
250300AMPMH5	Ø250/300	167,27 €

Ampliación asimétrica (PP)



CÓDIGO	Ø	€/UD
810AMPASIMH5	Ø80/100	50,24 €
811AMPASIMH5	Ø80/110	31,54 €
110125AMPASIMH5	Ø110/125	68,25 €
125160AMPASIMH5	Ø125/160	68,67 €
160200AMPASIMH5	Ø160/200	101,37 €

INSPECCIONES Y VÁLVULAS

Válvula salida vertical telescópica desmontable (PP)

Acabado

CÓDIGO	Ø	€/UD
8CCVAREG5	Ø80	77,39 €
10CCVAREG5	Ø100	79,78 €

Manguito toma de muestra (PP)

Acabado

CÓDIGO	Ø	€/UD
11TM5	110	25,68 €
125TM5	125	35,31 €
160TM5	160	53,50 €
200TM5	200	90,95 €
250TM5	250	107,00 €
300TM5	300	136,25 €

Módulo de inspección (PP)

Acabado

CÓDIGO	Ø	€/UD
11INSP5	110	60,00 €
125INSP5	125	63,00 €
160INSP5	160	95,00 €
200INSP5	200	100,00 €
250INSP5	250	175,00 €
300INSP5	300	250,00 €

COMPLEMENTOS

Anillo de seguridad unión Macho - Hembra (Acero)

Acabado

CÓDIGO	Ø	€/UD
125ABSOPORTFLEX	Ø125	12,54 €
160ABSOPORTFLEX	Ø160	22,89 €
200ABSOPORTFLEX	Ø200	30,52 €
250ABSOPORTFLEX	Ø250	40,03 €
300ABSOPORTFLEX	Ø300	52,16 €

Abrazadera a pared (Acero lacado/sin lacar)

Acabado

CÓDIGO	Ø	€/UD
11ABPR3	108	3,93 €
125ABPR3	123	4,19 €
160ABPR3	158	6,70 €
200ABPR3	198	7,21 €
250ABPR3	248	8,34 €
300ABPR3	298	8,94 €

SopORTE mural (Acero)

Acabado

CÓDIGO	Ø	€/UD
11SOPMURSP304	Ø110	18,92 €
125SOPMURSP304	Ø125	18,92 €
160SOPMURSP304	Ø160	20,18 €
200SOPMURSP304	Ø200	22,89 €
250SOPMURSP304	Ø250	23,98 €
300SOPMURSP304	Ø300	28,34 €

Alargador soporte mural (Acero)

Acabado

CÓDIGO	Ø	€/UD
105ALARGADOR		21,83 €
205ALARGADOR		29,11 €

Sifón (PP)

Acabado

CÓDIGO	Ø	€/UD
SIFON5		22,74 €

Adaptador exterior de coaxial (Ø60/Ø100) a biflujo (Ø80) (PP/Acero lacado)

Acabado

CÓDIGO	Ø	€/UD
610ENTRONASP15	Ø60/Ø100 a Ø80	28,34 €

TERMINALES

Terminal cono salida libre

Acabado

CÓDIGO	Ø	€/UD
110FINCONICO	Ø110	87,20 €
125150FINCONICO	Ø125	53,56 €
160180FINCONICO	Ø160	75,00 €
200250FINCONICO	Ø200	81,75 €
250300FINCONICO	Ø250	119,00 €
300350FINCONICO	Ø300	130,00 €

Deflector horizontal antiluvia exterior (PP)

Acabado

CÓDIGO	Ø	€/UD
11DFHALL5	Ø110	20,64 €
125DFHALL5	Ø125	23,05 €
160DFHALL5	Ø160	32,70 €

1
Reduce el tamaño de los patinillos

2
Gana eficiencia en la chimenea

3
Minimiza los costes de la instalación

Colectores con válvula incorporada para poder realizar la evacuación de humos en instalaciones colectivas verticales en sobrepresión o presión positiva



Chimeplast®

Instalaciones individuales y colectivas de alta potencia

PROTEGIDO

Conductos para evacuación de humos de aparatos de condensación en instalaciones colectivas verticales y horizontales, y calderas de gran potencia en EXTERIOR o patinillos compartidos.

Características.

- Material interior: Polipropileno.
- Material exterior: Acero inoxidable AISI 304 o AISI 316 (ver descripciones).
- Espesor mínimo pared interior: 2,2 mm.
- Combustible Gas o Gasoil.
- Unión entre piezas: Machihembrada.
- Junta estanqueidad: EPDM.
- Temperatura máxima 120°C.
- Color Inox.
- Designación de producto:
 - $\varnothing 125$, $\varnothing 160$: T120-H1-W-2-O00-LE-E-U0
 - $\varnothing 200$, $\varnothing 250$, $\varnothing 300$: T120-P1-W-2-O00-LE-E-U0
- Diámetros disponibles:
 - $\varnothing 125/\varnothing 150$ - $\varnothing 160/\varnothing 180$ - $\varnothing 200/\varnothing 250$ - $\varnothing 250/\varnothing 300$ - $\varnothing 300/\varnothing 350$



NOTA IMPORTANTE

Respetar inclinación mínima de 3° (5,2%) ascendente en instalaciones horizontales de conductos de evacuación de humos en polipropileno para aparatos a condensación.

(Norma EN 123001:2009, Apdo 5.5.1).

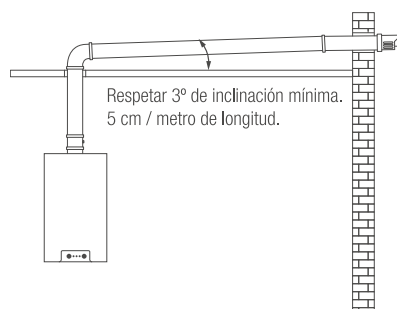

Los dibujos de las piezas son orientativos, FIG S.L. se reserva el derecho de cambiar las características de los productos sin previo aviso.

Las dimensiones de las piezas son aproximadas, FIG S.L. no se hace responsable de problemas en la instalación de las mismas.

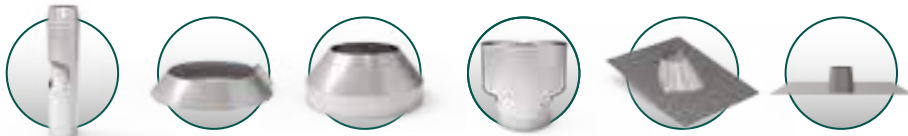

TERMINALES



COMPLEMENTOS



RECOGE CONDENSADOS

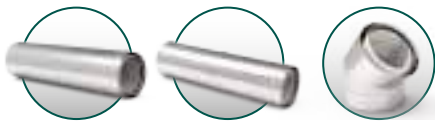

TUBOS Y CODOS



Instalación de evacuación por exterior

TUBOS

Tubo Macho - Hembra (PP/Inox)



Acabado ○●

CÓDIGO	Ø	€/UD
125150-500MH45	Ø125/150	50,29 €
125150-1000MH45	Ø125/150	83,46 €
160180-500MH45	Ø160/180	66,49 €
160180-1000MH45	Ø160/180	105,93 €
200250-500MH45	Ø200/250	91,56 €
200250-1000MH45	Ø200/250	130,80 €
250300-500MH45	Ø250/300	151,51 €
250300-1000MH45	Ø250/300	168,95 €
300350-500MH45	Ø300/350	179,85 €
300350-1000MH45	Ø300/350	187,48 €

TUBOS TELESCÓPICOS

Tubo Telescópico Macho - Hembra (PP/Inox)



Acabado ○●

CÓDIGO	Ø	€/UD
125150TLMH45	Ø125/150	90,47 €
160180TLMH45	Ø160/180	112,27 €
200250TLMH45	Ø200/250	136,25 €
250300TLMH45	Ø250/300	179,85 €
300350TLMH45	Ø300/350	199,47 €

CODOS

Codo 45° Macho - Hembra (PP/Inox)



Acabado ○●

CÓDIGO	Ø	€/UD
125150-45MH45	Ø125/150	80,25 €
160180-45MH45	Ø160/180	99,51 €
200250-45MH45	Ø200/250	123,17 €
250300-45MH45	Ø250/300	158,05 €
300350-45MH45	Ø300/350	178,44 €

RECOCHE CONDENSADOS

Te con recogida de condensados Macho - Hembra (PP/Inox)



Acabado ○●

CÓDIGO	Ø	€/UD
125150TE45	Ø125/150	155,25 €
160180TE45	Ø160/180	169,60 €
200250TE45	Ø200/250	221,40 €
250300TE45	Ø250/300	283,05 €
300350TE45	Ø300/350	296,64 €

Tapa desagüe de condensados (PP/Inox)



Acabado ○●

CÓDIGO	Ø	€/UD
125150TAPECOND	Ø125/150	49,45 €
160180TAPECOND	Ø160/180	49,49 €
200250TAPECOND	Ø200/250	67,58 €
250300TAPECOND	Ø250/300	74,12 €
300350TAPECOND	Ø300/350	88,29 €

COLECTORES

Colector vertical sólo evacuación Macho - Hembra (PP/Inox)



Acabado ○●

CÓDIGO	Ø	€/UD
125150COLVERT45	Ø125/150	103,55 €
160180COLVERT45	Ø160/180	130,80 €
200250COLVERT45	Ø200/250	177,09 €
250300COLVERT45	Ø250/300	221,97 €
300350COLVERT45	Ø300/350	247,26 €

Colector vertical válvula antirretorno Macho - Hembra (PP/Inox)



Acabado ○●

CÓDIGO	Ø	€/UD
125150COLPOS45	Ø125/150	132,98 €
160180COLPOS45	Ø160/180	163,50 €
200250COLPOS45	Ø200/250	207,10 €
250300COLPOS45	Ø250/300	256,59 €
300350COLPOS45	Ø300/350	272,50 €

COMPLEMENTOS

Teja inclinada 30° (Inox)

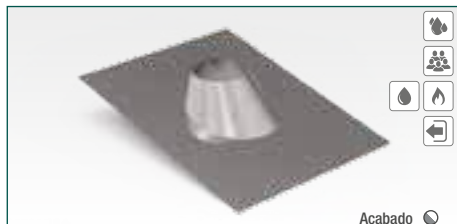

CÓDIGO	Ø	€/UD
150TEJA30SP304	Ø150	85,02 €
180TEJA30SP304	Ø180	86,11 €
250TEJA30SP304	Ø250	119,90 €
300TEJA30SP304	Ø300	155,87 €
350TEJA30SP304	Ø350	158,05 €

Teja plana (Inox)



CÓDIGO	Ø	€/UD
150TEJASP304	Ø150	85,02 €
180TEJASP304	Ø180	86,11 €
250TEJASP304	Ø250	119,90 €
300TEJASP304	Ø300	158,05 €
350TEJASP304	Ø350	163,28 €

Brida antivientos (Inox)



CÓDIGO	Ø	€/UD
150ABRVIENTSP304	Ø150	19,62 €
180ABRVIENTSP304	Ø180	20,71 €
250ABRVIENTSP304	Ø250	23,98 €
300ABRVIENTSP304	Ø300	23,66 €
350ABRVIENTSP304	Ø350	25,62 €

Soporte chimenea (Inox)



CÓDIGO	Ø	€/UD
125150SOPCHI45	Ø125/150	157,68 €
160180SOPCHI45	Ø160/180	188,01 €
200250SOPCHI45	Ø200/250	278,98 €
250300SOPCHI45	Ø250/300	376,02 €
300350SOPCHI45	Ø300/350	485,18 €

Vierteaguas (Inox)



CÓDIGO	Ø	€/UD
150VIERTEAGUASP	Ø150	28,89 €
180VIERTEAGUASP	Ø180	29,43 €
250VIERTEAGUASP	Ø250	34,34 €
300VIERTEAGUASP	Ø300	35,97 €
350VIERTEAGUASP	Ø350	38,15 €

Soporte mural (Inox)



CÓDIGO	Ø	€/UD
150SOPMURSP304	Ø150	20,81 €
180SOPMURSP304	Ø180	20,99 €
250SOPMURSP304	Ø250	23,98 €
300SOPMURSP304	Ø300	28,34 €
350SOPMURSP304	Ø350	32,75 €

Alargador soporte mural (Acero)



CÓDIGO	Ø	€/UD
105ALARGADOR		21,83 €
205ALARGADOR		29,11 €

Abrazadera a pared (Inox)



CÓDIGO	Ø	€/UD
150ABPR3	Ø150	6,18 €
180ABRSP304	Ø180	11,08 €

TERMINALES

Salida a techo (PP/Inox)



CÓDIGO	Ø	€/UD
125150ST45	Ø125/150	134,93 €
160180ST45	Ø160/180	164,80 €
200250ST45	Ø200/250	261,60 €
250300ST45	Ø250/300	316,10 €
300350ST45	Ø300/350	354,25 €

Terminal vertical antirretorno (Inox)



CÓDIGO	Ø	€/UD
125150DFV4	Ø125/150	83,93 €
160180DFV4	Ø160/180	103,50 €
200250DFV4	Ø200/250	150,00 €
250300DFV4	Ø250/300	168,00 €
300350DFV4	Ø300/350	192,00 €

Terminal cono libre (Inox)



CÓDIGO	Ø	€/UD
125150FINCONICO	Ø125/150	53,56 €
160180FINCONICO	Ø160/180	75,00 €
200250FINCONICO	Ø200/250	81,75 €
250300FINCONICO	Ø250/300	119,00 €
300350FINCONICO	Ø300/350	130,00 €

Chimeplast®

Instalaciones individuales y colectivas de alta potencia

COAXIAL

Conductos para evacuación de humos y aspiración de aire de combustión, de aparatos de condensación en instalaciones colectivas verticales y calderas de gran potencia en EXTERIOR o patinillos compartidos.

Características

- Material interior: Polipropileno.
- Material exterior: Acero inoxidable AISI 304 o AISI 316 (ver descripciones).
- Espesor mínimo pared interior: 2,2 mm.
- Combustible Gas o Gasoil.
- Unión entre piezas: Machihembrada.
- Junta estanqueidad: EPDM.
- Temperatura máxima 120°C.
- Color Inox.
- Designación de producto:
 - $\varnothing 125$, $\varnothing 160$: T120-H1-W-2-O00-LE-E-U0
 - $\varnothing 200$, $\varnothing 250$, $\varnothing 300$: T120-P1-W-2-O00-LE-E-U0
- Diámetros disponibles:
 - $\varnothing 125/\varnothing 200$ - $\varnothing 160/\varnothing 250$ - $\varnothing 200/\varnothing 350$ - $\varnothing 250/\varnothing 400$ - $\varnothing 300/\varnothing 450$



NOTA IMPORTANTE

Respetar inclinación mínima de 3° (5,2%) ascendente en instalaciones horizontales de conductos de evacuación de humos en polipropileno para aparatos a condensación.

(Norma EN 123001:2009, Apdo 5.5.1).

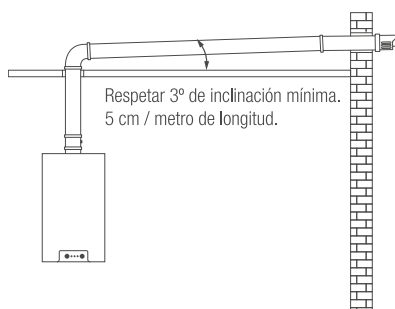

Los dibujos de las piezas son orientativos, FIG S.L. se reserva el derecho de cambiar las características de los productos sin previo aviso. Las dimensiones de las piezas son aproximadas, FIG S.L. no se hace responsable de problemas en la instalación de las mismas.



TERMINALES



COMPLEMENTOS



RECOGE CONDENSADOS

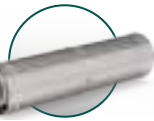

TUBOS Y CODOS

Instalación coaxial de evacuación y aspiración por exterior

TUBOS

Tubo coaxial Macho - Hembra (PP/Inox)



CÓDIGO	Ø	€/UD
125200-500MH45	Ø125/Ø200	63,13 €
125200-1000MH45	Ø125/Ø200	105,93 €
160250-500MH45	Ø160/Ø250	85,60 €
160250-1000MH45	Ø160/Ø250	149,80 €
200350-500MH45	Ø200/Ø350	117,70 €
200350-1000MH45	Ø200/Ø350	173,25 €
250400-500MH45	Ø250/Ø400	179,85 €
250400-1000MH45	Ø250/Ø400	220,76 €
300450-500MH45	Ø300/Ø450	212,55 €
300450-1000MH45	Ø300/Ø450	242,59 €

TUBOS TELESCÓPICOS

Módulo extensible coaxial (telescópico) (PP/Inox)



CÓDIGO	Ø	€/UD
125200TLMH45	Ø125/Ø200	107,91 €
160250TLMH45	Ø160/Ø250	147,15 €
200350TLMH45	Ø200/Ø350	179,85 €
250400TLMH45	Ø250/Ø400	235,31 €
300450TLMH45	Ø300/Ø450	261,60 €

CODOS

Codo 45° coaxial Macho - Hembra (PP/Inox)



CÓDIGO	Ø	€/UD
125200-45MH45	Ø125/Ø200	96,30 €
160250-45MH45	Ø160/Ø250	128,40 €
200350-45MH45	Ø200/Ø350	159,55 €
250400-45MH45	Ø250/Ø400	194,08 €
300450-45MH45	Ø300/Ø450	217,53 €

RECOCGE CONDENSADOS

Te coaxial con recogida de condensados Macho - Hembra (PP/Inox)



CÓDIGO	Ø	€/UD
125200TE45	Ø125/Ø200	177,67 €
160250TE45	Ø160/Ø250	207,10 €
200350TE45	Ø200/Ø350	263,62 €
250400TE45	Ø250/Ø400	369,95 €
300450TE45	Ø300/Ø450	425,10 €

Tapa desagüe de condensados (PP/Inox)



CÓDIGO	Ø	€/UD
125200TAPECOND	Ø125/Ø200	61,09 €
160250TAPECOND	Ø160/Ø250	70,60 €
200350TAPECOND	Ø200/Ø350	82,81 €
250400TAPECOND	Ø250/Ø400	115,00 €
300450TAPECOND	Ø300/Ø450	130,80 €

COLECTORES

Colector coaxial vertical Macho - Hembra (PP/Inox)



CÓDIGO	Ø	€/UD
125200COLVERT45	Ø125/Ø200	129,79 €
160250COLVERT45	Ø160/Ø250	163,50 €
200350COLVERT45	Ø200/Ø350	218,33 €
250400COLVERT45	Ø250/Ø400	288,68 €
300450COLVERT45	Ø300/Ø450	326,56 €

Colector vertical coaxial válvula antirretorno Macho - Hembra (PP/Inox)



CÓDIGO	Ø	€/UD
125200COLCOAPP45	Ø125/Ø200	161,32 €
160250COLCOAPP45	Ø160/Ø250	190,75 €
200350COLCOAPP45	Ø200/Ø350	248,66 €
250400COLCOAPP45	Ø250/Ø400	315,37 €
300450COLCOAPP45	Ø300/Ø450	348,72 €

Entrada colector Ø60x100 / 80x125 (PP)



CÓDIGO	Ø	€/UD
6810125ENTRON15	Ø60/Ø100 - Ø80/Ø125	25,07 €

COMPLEMENTOS

Teja inclinada 30° (Inox)

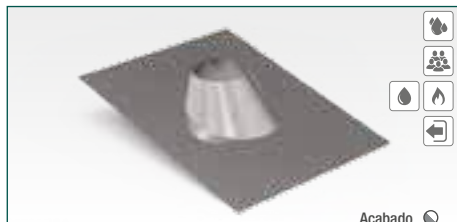

Acabado

CÓDIGO	Ø	€/UD
200TEJA30SP304	Ø200	122,08 €
250TEJA30SP304	Ø250	119,90 €
350TEJA30SP304	Ø350	158,05 €
400TEJA30SP304	Ø400	185,30 €
450TEJA30SP304	Ø450	218,00 €

Teja Plana (Inox)



Acabado

CÓDIGO	Ø	€/UD
200TEJASP304	Ø200	119,90 €
250TEJASP304	Ø250	119,90 €
350TEJASP304	Ø350	163,28 €
400TEJASP304	Ø400	179,85 €
450TEJASP304	Ø450	212,55 €

Brida antivientos (Inox)



Acabado

CÓDIGO	Ø	€/UD
200ABRVIENTSP304	Ø200	20,71 €
250ABRVIENTSP304	Ø250	23,98 €
350ABRVIENTSP304	Ø350	25,62 €
400ABRVIENTSP304	Ø400	32,70 €
450ABRVIENTSP304	Ø450	35,97 €

Vierteaguas (Inox)



Acabado

CÓDIGO	Ø	€/UD
200VIERTEAGUASP	Ø200	33,79 €
250VIERTEAGUASP	Ø250	34,34 €
350VIERTEAGUASP	Ø350	38,15 €
400VIERTEAGUASP	Ø400	43,60 €
450VIERTEAGUASP	Ø450	50,14 €

Soporte mural (Inox)



Acabado

CÓDIGO	Ø	€/UD
200SOPMURSP304	Ø200	22,89 €
250SOPMURSP304	Ø250	23,98 €
350SOPMURSP304	Ø350	32,75 €
400SOPMURSP304	Ø400	39,24 €
450SOPMURSP304	Ø450	46,87 €

Alargador soporte mural (Acero)



Acabado

CÓDIGO	Ø	€/UD
105ALARGADOR		21,83 €
205ALARGADOR		29,11 €

Abrazadera a pared (Inox)

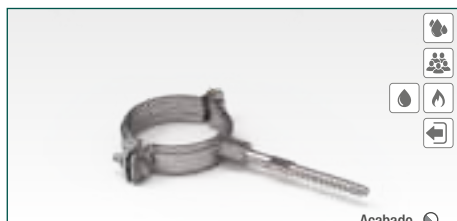

Acabado

CÓDIGO	Ø	€/UD
200ABPR3	Ø200	7,21 €

TERMINALES

Salida a techo coaxial cono libre (PP/Inox)



Acabado

CÓDIGO	Ø	€/UD
125200COAXCONO45	Ø125/200	201,85 €
160250COAXCONO45	Ø160/250	251,45 €
200350COAXCONO45	Ø200/350	331,70 €
250400COAXCONO45	Ø250/400	403,67 €
300450COAXCONO45	Ø300/450	479,70 €

Aeroplast

CONDUCTOS Y COMPONENTES PARA BOMBAS DE CALOR ACS



SIMPLE PARED

Conductos para evacuación de humos de bombas de calor ACS en instalaciones INDIVIDUALES por el interior.

Características:

- Espesor mínimo pared interior: 2,2 mm.
- Combustible: Aerotermia.
- Temperatura máxima: 120°C.
- Color: Blanco.
- Unión entre piezas: Machihembrada.
- Junta de estanqueidad: EPDM.
- Designación de producto:
 - \varnothing 125, \varnothing 160: T120-H1-W-2-0-20-LI-E-U
 - \varnothing 200: T120-P1-W-2-0-20-LI-E-U
- Diámetros disponibles:
 - \varnothing 125 - \varnothing 160 - \varnothing 200

COAXIAL

Conductos para evacuación de humos de bombas de calor ACS en instalaciones INDIVIDUALES por el interior.

Características.

- Material interior: PP.
- Material exterior: Acero lacado.
- Espesor pared interior: 1,5 mm (min).
- Combustible: Aerotermia.
- Temperatura máxima: 120°C.
- Unión entre piezas: Machihembrada con junta de estanqueidad en interior y exterior.
- Color: Blanco.
- Junta: EPDM.
- Designación de producto:
 - T120-H1-W-2-0-00-LI-E-U0
- Diámetros disponibles:
 - \varnothing 80/ \varnothing 125

FLEXIBLE

Conductos para evacuación de humos de bombas de calor ACS en instalaciones INDIVIDUALES por el interior.

Características:

- Material:
 - PP corrugado.
- Espesor mínimo pared conducto: 1,5 mm.
- Combustible: Aerotermia.
- Temperatura máxima: 120°C.
- Color: Blanco.
- Designación de producto:
 - T120-H1-W-2-020-LI-E-U
- Diámetros disponibles:
 - \varnothing 125 - \varnothing 160 - \varnothing 200

Aeroplast

Bombas de calor ACS

SIMPLE PARED Y COAXIAL

Conductos para evacuación de humos de bombas de calor ACS en instalaciones INDIVIDUALES por el interior.

Características simple pared:

- Espesor mínimo pared interior: 2,2 mm.
- Combustible: Aerotermia.
- Temperatura máxima: 120°C.
- Color: Blanco.
- Unión entre piezas: Machihembra.
- Junta de estanqueidad: EPDM.
- Designación de producto:
 - \varnothing 125, \varnothing 160: T120-H1-W-2-0-20-LI-E-U
 - \varnothing 200: T120-P1-W-2-0-20-LI-E-U
- Diámetros disponibles:
 - \varnothing 125 - \varnothing 160 - \varnothing 200

Características coaxial.

- Material interior: PP.
- Material exterior: Acero lacado.
- Espesor pared interior: 1,5 mm (min).
- Combustible: Aerotermia.
- Temperatura máxima: 120°C.
- Unión entre piezas: Machihembra con junta de estanqueidad en interior y exterior.
- Color: Blanco.
- Junta: EPDM.
- Designación de producto:
 - T120-H1-W-2-0-00-LI-E-U0
- Diámetros disponibles:
 - \varnothing 80/ \varnothing 125

Características flexible:

- Material:
 - PP corrugado.
- Espesor mínimo pared conducto: 1,5 mm.
- Combustible: Aerotermia.
- Temperatura máxima: 120°C.
- Color: Blanco.
- Designación de producto:
 - T120-H1-W-2-020-LI-E-U
- Diámetros disponibles:
 - \varnothing 125 - \varnothing 160 - \varnothing 200



Los dibujos de las piezas son orientativos, FIG S.L. se reserva el derecho de cambiar las características de los productos sin previo aviso.
Las dimensiones de las piezas son aproximadas, FIG S.L. no se hace responsable de problemas en la instalación de las mismas.



TERMINALES



AMPLIACIONES Y RECOGE CONDENSADOS



TUBOS Y CODOS



COMPATIBLES CON: ARISTON / VAILLANT / THERMOR / JUNKERS / DAIKIN / MITSUBISHI / BAXI

TUBOS

Tubo Macho - Hembra (PP)



Acabado ○

CÓDIGO	Ø	LONGITUD	€/UD
125-500MH5	Ø125	500	17,66 €
125-1000MH5	Ø125	1000	31,54 €
125-2000MH5	Ø125	2000	46,65 €
160-500MH5	Ø160	500	29,43 €
160-1000MH5	Ø160	1000	46,65 €
160-2000MH5	Ø160	2000	71,90 €
200-500MH5	Ø200	500	47,96 €
200-1000MH5	Ø200	1000	58,86 €
200-2000MH5	Ø200	2000	113,13 €

CODOS

Codo 90° Macho - Hembra (PP)



Acabado ○

CÓDIGO	Ø	€/UD
125-90MH5	Ø125	21,26 €
160-90MH5	Ø160	37,84 €
200-90MH5	Ø200	50,46 €

Codo 45° Macho - Hembra (PP)



Acabado ○

CÓDIGO	Ø	€/UD
125-45MH5	Ø125	18,92 €
160-45MH5	Ø160	29,01 €
200-45MH5	Ø200	44,15 €

AMPLIACIONES Y RECOGE CONDENSADOS

Ampliación Macho - Hembra (PP)



Acabado ○

CÓDIGO	Ø	€/UD
125160AMPMH5	Ø125 - Ø160	58,03 €
150160AMPMH5	Ø150 - Ø160	80,25 €
160200AMPMH5	Ø160 - Ø200	72,06 €

Te recoge condensados con tape (PP)



Acabado ○

CÓDIGO	Ø	€/UD
125TE5	Ø125	58,22 €
160TE5	Ø160	86,11 €
200TE5	Ø200	93,74 €

COMPLEMENTOS

Sifón



CÓDIGO	Ø	€/UD
SIFON5		22,74 €

TERMINALES

Deflector horizontal antilluvia exterior (PP)



Acabado ○

CÓDIGO	Ø	€/UD
125DFHALL5	Ø125	23,05 €
160DFHALL5	Ø160	32,70 €
200DFHALL5	Ø200	consultar

COMPATIBLES CON: JUNKERS / SAUNIER DUVAL

KITS

Kit coaxial (codo 8125-90MHP15 + terminal 8125TDFHP15 + plafones Ø125)



Acabado

CÓDIGO	Ø	€/UD
8125KCCRMHP15	Ø80/Ø125	97,04 €

TUBOS

Tubo Coaxial Macho - Hembra (PP)



Acabado

CÓDIGO	Ø	LONGITUD	€/UD
8125-500MHP15	Ø80/Ø125	500	25,07 €
8125-1000MHP15	Ø80/Ø125	1000	33,25 €

CODOS

Codo 90° Coaxial Macho - Hembra (PP)



Acabado

CÓDIGO	Ø	€/UD
8125-90MHP15	Ø80/Ø125	41,17 €

Codo 45° Coaxial Macho - Hembra (PP)



Acabado

CÓDIGO	Ø	€/UD
8125-45MHP15	Ø80/Ø125	38,21 €

FLEXIBLE

TUBOS

Tubo flexible unión por manguitos (PP)



Acabado

CÓDIGO	Ø	LONGITUD	€/UD
125FLEXCONT5	Ø125	20 m	604,95 €
160FLEXCONT5	Ø160	20 m	730,30 €
200FLEXCONT5	Ø200	20 m	882,90 €

Kit manguitos unión tubo flexible (PP)



Acabado

CÓDIGO	Ø	€/UD
125UNIONFLEX5	Ø125	25,07 €
160UNIONFLEX5	Ø160	99,00 €
200UNIONFLEX5	Ø200	111,00 €

Tubo flexible antibacteriano con el interior liso (Polietileno)



Acabado

CÓDIGO	Ø	LONGITUD	€/UD
75-50VENTOFLEX5	Ø75	50 m	274,08 €
90-50VENTOFLEX5	Ø90	50 m	384,88 €

ALUONE

CONDUCTOS Y COMPONENTES DE ALUMINIO PARA APARATOS
TRADICIONALES EN INSTALACIONES INDIVIDUALES INTERIORES



SIMPLE PARED

Conductos para evacuación de humos y aspiración de aire de combustión por conductos separados, en aparatos NO condensación en instalaciones individuales en INTERIOR.

Características:

- Material: Aluminio.
- Espesor mínimo pared interior: 1 mm.
- Combustible: Gas.
- Temperatura máxima: 200°C.
- Color Blanco pintado epoxi.
- Unión entre piezas: Machihembrada.
- Junta de estanqueidad: Silicona.
- Designación de producto:
 - T200-P1-D-Vm-L13100-070
- Diámetros disponibles:
 - ø80

SIMPLE - CÁMARA ABIERTA

Conductos para evacuación de humos de combustión, en aparatos NO condensación de tiro natural o forzado en instalaciones individuales en INTERIOR.

Características:

- Material: Aluminio.
- Espesor pared conducto 1 mm (min).
- Combustible: Gas.
- Temperatura máxima: 200°C.
- Unión entre piezas: Machihembrada.
- Juntas de estanqueidad: Silicona.
- Color Blanco pintado epoxi.
- Designación de producto:
 - T160-P1-D-Vm-L13100-O(150) M
- Diámetros disponibles:
 - ø80 - ø100 - ø110 - ø127 - ø132

COAXIAL

Conductos para evacuación de humos y aspiración de aire de combustión por conductos COAXIALES, en aparatos NO condensación en instalaciones individuales en INTERIOR.

Características:

- Material interior: Aluminio.
- Material exterior: Acero lacado.
- Espesor mínimo pared interior: 1 mm.
- Combustible Gas.
- Temperatura máxima 200°C.
- Unión entre piezas: Machihembrada.
- Color: Blanco pintado epoxi.
- Juntas de estanqueidad: Silicona.
- Designación de producto:
 - T200-P1-D-Vm-L13100-O00
- Diámetros disponibles:
 - ø60/100 - ø80/110 - ø80/125

ALUONE

Tiro forzado

SIMPLE PARED

Conductos para evacuación de humos y aspiración de aire de combustión por conductos separados, en aparatos NO condensación en instalaciones individuales en INTERIOR.

Características:

- Material: Aluminio.
- Espesor mínimo pared interior: 1 mm.
- Combustible: Gas.
- Temperatura máxima: 200°C.
- Color Blanco pintado epoxi.
- Unión entre piezas: Machihembrada.
- Junta de estanqueidad: Silicona.
- Designación de producto:
 - T200-P1-D-Vm-L13100-070
- Diámetros disponibles:
 - ø80



Los dibujos de las piezas son orientativos, FIG S.L. se reserva el derecho de cambiar las características de los productos sin previo aviso.
Las dimensiones de las piezas son aproximadas, FIG S.L. no se hace responsable de problemas en la instalación de las mismas.



TERMINALES TEJA



COMPLEMENTOS Y ADAPTADORES



TERMINALES



INSPECCIONES



RECOGE CONDENSADOS



AMPLIACIONES Y MANGUITOS



CODOS



TUBOS



TUBOS

Tubo Macho - Hembra (Aluminio lacado)



Acabado

CÓDIGO	UNIÓN	Ø	LONGITUD	€/UD
8-250MHP1	M-H	Ø80	250 mm	6,60 €
8-500MHP1	M-H	Ø80	500 mm	12,38 €
8-1000MHP1	M-H	Ø80	1000 mm	16,00 €
8-1500MHP1	M-H	Ø80	1500 mm	22,20 €
8-2000MHP1	M-H	Ø80	2000 mm	28,44 €

Tubo Macho - Macho (Aluminio lacado)



Acabado

CÓDIGO	UNIÓN	Ø	LONGITUD	€/UD
8-250MMP1	M-M	Ø80	250 mm	5,89 €
8-500MMP1	M-M	Ø80	500 mm	10,24 €
8-1000MMP1	M-M	Ø80	1000 mm	19,29 €
8-1500MMP1	M-M	Ø80	1500 mm	29,26 €
8-2000MMP1	M-M	Ø80	2000 mm	29,97 €

CODOS

Codo 90° Macho - Hembra (Aluminio lacado)



Acabado

CÓDIGO	UNIÓN	Ø	€/UD
8-90MHP1	M-H	Ø80	9,10 €

Codo 90° Hembra - Hembra (Aluminio lacado)



Acabado

CÓDIGO	UNIÓN	Ø	€/UD
8-90HHP1	H-H	Ø80	10,51 €

Codo 45° Macho - Hembra (Aluminio lacado)



Acabado

CÓDIGO	UNIÓN	Ø	€/UD
8-45MHP1	M-H	Ø80	9,10 €

Codo 45° Hembra- Hembra (Aluminio lacado)

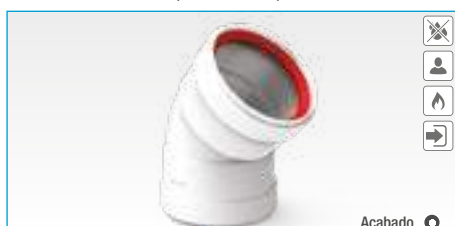

Acabado

CÓDIGO	UNIÓN	Ø	€/UD
8-45HHP1	H-H	Ø80	10,51 €

RECOGE CONDENSADOS

Te con recogida de condensados Macho - Hembra (Aluminio lacado)

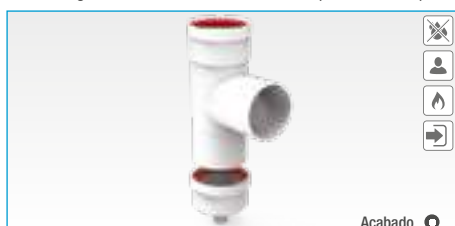

Acabado

CÓDIGO	Ø	€/UD
8TEP1	Ø80	38,69 €

Manguito recoge condensados Macho - Hembra (Aluminio lacado)



Acabado

CÓDIGO	Ø	€/UD
8RCMHP1	Ø80	25,18 €

AMPLIACIONES Y MANGUITOS

Ampliación Macho - Hembra (Aluminio pintado)



Acabado

CÓDIGO	Ø	€/UD
68AMPMPH1	Ø60/80	13,30 €
810AMPMPH1	Ø80/100	13,30 €
8127AMPMPH1	Ø80/127	19,64 €

Manguito unión para tubos Macho - Macho (Aluminio lacado)



Acabado

CÓDIGO	Ø	€/UD
8MTTP1	Ø80	5,43 €

Manguito telescópico Macho - Hembra (Aluminio lacado)



Acabado

CÓDIGO	Ø	€/UD
8TLMHP1	Ø80	18,32 €

INSPECCIONES

Manguito con toma de muestras Macho - Hembra (Aluminio lacado)



Acabado

CÓDIGO	Ø	€/UD
8TMMHP1	Ø80	10,36 €

Toma de muestras (Silicona)



Acabado

CÓDIGO	Ø	€/UD
TMSILICONA		1,44 €

COMPLEMENTOS

Abrazadera pared (Acero pintado)



Acabado

CÓDIGO	Ø	€/UD
8ABPRP3	Ø80	4,25 €

Plafón (EPDM)



Acabado

CÓDIGO	Ø	€/UD
8PL6	Ø80	2,72 €

Plafón (Acero lacado)



Acabado

CÓDIGO	Ø	€/UD
8PL3	Ø80	7,96 €

Junta labiada (silicona)



Acabado

CÓDIGO	Ø	€/UD
8JTSIL	Ø80	0,72 €

Teja



Acabado

CÓDIGO	Ø	€/UD
TEJA	Ø80	53,01 €

Teja plana



Acabado

CÓDIGO	Ø	€/UD
TEJAPLANAP1	Ø80	30,32 €

TERMINALES

Deflector evacuación vertical (Inox)

Acabado

CÓDIGO	Ø	€/UD
8DFV4	Ø80	17,88 €

Deflector evacuación horizontal (Inox)

Acabado

CÓDIGO	Ø	€/UD
8DFH4	Ø80	8,18 €

Deflector evacuación desviador humos lateral regulable (Aluminio/Inox)

90°

Acabado

CÓDIGO	Ø	€/UD
8DFHREP14	Ø80	22,89 €

Deflector evacuación salida cañón (Inox)

Acabado

CÓDIGO	Ø	€/UD
8DFHCA4	Ø80	6,98 €

Deflector horizontal antilluvia (Aluminio)

Acabado

CÓDIGO	Ø	€/UD
8DFHALLP1	Ø80	17,03 €

Deflector aspiración horizontal (Nylon)

Acabado

CÓDIGO	Ø	€/UD
8DFH7	Ø80	3,64 €

Salida a techo (Aluminio/PVC)

Acabado

CÓDIGO	Ø	€/UD
8ST18	Ø80	96,57 €

Terminal vertical corto (Aluminio/PVC)

Acabado

CÓDIGO	Ø	€/UD
8DFV18	Ø80	27,91 €



ADAPTADORES BIFLUJO COMPATIBLES

8ADBFAP1



Acabado

CÓDIGO	MODELO	Ø	€/UD
ARISTON	T/M	Ø80	43,67 €
BAXI	T/M	Ø80	
CHAFFOTEAUX	AVENIR	Ø80	
FAGOR	T/M	Ø80	
FONDITAL	LIPARI TF	Ø80	
THERMOR	TOP SEALED	Ø80	
SAUNIER	OPALIATHERM	Ø80	
VAILLANT	TURBOMAG	Ø80	

8ADBBEP1



Acabado

CÓDIGO	MODELO	Ø	€/UD
BERETTA	T/M	Ø80	44,88 €
VANWARDIST	T/M	Ø80	
CORBERO	T/M	Ø80	
COBETA	T/M	Ø80	

8ADBUP1



Acabado

CÓDIGO	MODELO	Ø	€/UD
COINTRA	T/M	Ø80	35,67 €
FORCALI	T/M	Ø80	

8ADBCALGDAP1



Acabado

CÓDIGO	MODELO	Ø	€/UD
HTW	T/M	Ø80	46,62 €

8ADBJKP1



Acabado

CÓDIGO	MODELO	Ø	€/UD
JUNKERS	T/M	Ø80	56,87 €

8ADBSDP1



Acabado

CÓDIGO	MODELO	Ø	€/UD
SAUNIER DUVAL	T/M	Ø80	63,27 €



ALUONE

Cámara abierta

SIMPLE - CÁMARA ABIERTA

Conductos para evacuación de humos de combustión, en aparatos NO condensación de tiro natural o forzado en instalaciones individuales en INTERIOR.

Características:

- Material: Aluminio.
- Espesor pared conducto 1 mm (min).
- Combustible: Gas.
- Temperatura máxima: 200°C.
- Unión entre piezas: Machihembrada.
- Juntas de estanqueidad: Silicona.
- Color Blanco pintado epoxi.
- Designación de producto:
 - T160-P1-D-Vm-L13100-O(150) M
- Diámetros disponibles:
 - $\varnothing 100$ - $\varnothing 110$ - $\varnothing 127$ - $\varnothing 132$



Los dibujos de las piezas son orientativos, FIG S.L. se reserva el derecho de cambiar las características de los productos sin previo aviso.
Las dimensiones de las piezas son aproximadas, FIG S.L. no se hace responsable de problemas en la instalación de las mismas.



TERMINALES

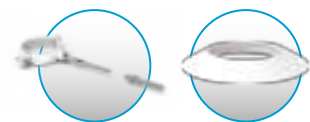

COMPLEMENTOS



AMPLIACIONES Y MANGUITOS



TUBOS Y CODOS



TUBOS

Tubo Macho - Hembra (Aluminio lacado)



	CÓDIGO	UNIÓN	Ø	LONGITUD	€/UD
espesor = 0,6 mm	11-500-06MMP1	H-H	Ø110	500 mm	12,75 €
	11-1000-06MMP1	H-H	Ø110	1000 mm	23,98 €
	127-500-06MMP1	H-H	Ø127	500 mm	13,35 €
	127-1000-06MMP1	H-H	Ø127	1000 mm	24,15 €

Tubo Macho - Macho (Aluminio lacado)



	CÓDIGO	UNIÓN	Ø	LONGITUD	€/UD
espesor = 1 mm	10-500MMP1	H-H	Ø100	500 mm	14,49 €
	10-1000MMP1	H-H	Ø100	1000 mm	27,23 €
	10-1500MMP1	H-H	Ø100	1500 mm	40,31 €
	10-2000MMP1	H-H	Ø100	2000 mm	51,85 €
	11-500MMP1	H-H	Ø110	500 mm	16,68 €
	11-1000MMP1	H-H	Ø110	1000 mm	31,72 €
	11-1500MMP1	H-H	Ø110	1500 mm	46,60 €
	11-2000MMP1	H-H	Ø110	2000 mm	60,39 €
	127-500MMP1	H-H	Ø127	500 mm	19,12 €
	127-1000MMP1	H-H	Ø127	1000 mm	36,60 €
	127-1500MMP1	H-H	Ø127	1500 mm	53,68 €
	127-2000MMP1	H-H	Ø127	2000 mm	70,15 €
	13-500MMP1	H-H	Ø130	500 mm	19,60 €
	13-1000MMP1	H-H	Ø130	1000 mm	37,58 €
	13-1500MMP1	H-H	Ø130	1500 mm	54,90 €
	13-2000MMP1	H-H	Ø130	2000 mm	71,98 €

CODOS

Codo 90° Hembra - Hembra (Aluminio lacado)



	CÓDIGO	UNIÓN	Ø	€/UD
	10-90HHP1	H-H	Ø100	12,32 €
	11-90HHP1	H-H	Ø110	16,16 €
	127-90HHP1	H-H	Ø127	17,17 €
	13-90HHP1	H-H	Ø130	16,67 €

Codo 45° Hembra - Hembra (Aluminio lacado)



	CÓDIGO	UNIÓN	Ø	€/UD
	10-45HHP1	H-H	Ø100	10,71 €
	11-45HHP1	H-H	Ø110	13,43 €
	127-45HHP1	H-H	Ø127	14,65 €
	13-45HHP1	H-H	Ø130	13,84 €

AMPLIACIONES, MANGUITOS Y CONEXIONES A CALDERA

Ampliación Macho - Hembra (Aluminio lacado)

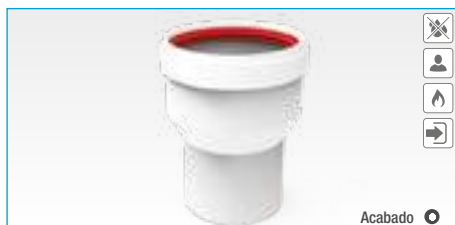

	CÓDIGO	Ø	€/UD
	1011AMPMHP1	Ø100/Ø110	23,00 €
	10127AMPMHP1	Ø100/Ø127	23,58 €
	11127AMPMHP1	Ø110/Ø127	23,58 €
	12713AMPMHP1	Ø127/Ø130	24,86 €

Manguito unión tubos macho macho Hembra - Hembra (Aluminio lacado)



	CÓDIGO	UNIÓN	Ø	€/UD
	10MTTP1	H-H	Ø100	8,21 €
	11MTTP1	H-H	Ø110	9,07 €
	127MTTP1	H-H	Ø127	10,08 €
	13MTTP1	H-H	Ø130	10,53 €

Conexión caldera con toma de muestras (Aluminio lacado)



	CÓDIGO	Ø	€/UD
	118110-200MMTTP1	Ø118 / Ø110	28,28 €
	130127-200MMTTP1	Ø130 / Ø127	28,28 €
	133127-200MMTTP1	Ø133 / Ø127	28,28 €
	135127-200MMTTP1	Ø135 / Ø127	28,79 €

COMPLEMENTOS

Abrazadera pared (Acero lacado)



Acabado

CÓDIGO	Ø	€/UD
10ABPRP3	Ø100	4,08 €
11ABPRP3	Ø110	3,93 €
125ABPRP3	Ø127 / Ø132	4,19 €

Plafón (Acero lacado)



Acabado

CÓDIGO	Ø	€/UD
10PL3	Ø100	5,94 €
11PL3	Ø110	6,00 €
127PL3	Ø127	6,76 €
13PL3	Ø132	6,76 €

Toma de muestras (Silicona)



CÓDIGO	Ø	€/UD
TMSILICONA		1,44 €

TERMINALES

Deflector evacuación vertical (Inox)



Acabado

CÓDIGO	Ø	€/UD
10DFV4	Ø100	23,44 €

Deflector evacuación horizontal (Inox)



Acabado

CÓDIGO	Ø	€/UD
10DFH4	Ø100	14,17 €

Deflector horizontal antilluvia (Aluminio)



Acabado

CÓDIGO	Ø	€/UD
10DFHALLP1	Ø100	19,62 €

Deflector 3 alas aluminio (Aluminio lacado)



Acabado

CÓDIGO	Ø	€/UD
10DFHEP1	Ø100	11,02 €
11DFHEP1	Ø110	11,02 €
127DFHEP1	Ø127	12,36 €
13DFHEP1	Ø132	13,39 €

Deflector 3 alas (Acero lacado)



Acabado

CÓDIGO	Ø	€/UD
10DFHEP3	Ø100	8,08 €
11DFHEP3	Ø110	8,08 €
127DFHEP3	Ø127	8,08 €
13DFHEP3	Ø132	8,08 €

ALUONE

Cámara estanca

COAXIAL

Conductos para evacuación de humos y aspiración de aire de combustión por conductos COAXIALES, en aparatos NO condensación en instalaciones individuales en INTERIOR.

Características:

- Material interior: Aluminio.
- Material exterior: Acero lacado.
- Espesor mínimo pared interior: 1 mm.
- Combustible Gas.
- Temperatura máxima 200°C.
- Unión entre piezas: Machihembrada.
- Color: Blanco pintado epoxi.
- Juntas de estanqueidad: Silicona.
- Designación de producto:
 - T200-P1-D-Vm-L13100-O00
- Diámetros disponibles:
 - $\varnothing 60/100$ - $\varnothing 80/110$ - $\varnothing 80/125$



Los dibujos de las piezas son orientativos, FIG S.L. se reserva el derecho de cambiar las características de los productos sin previo aviso.
Las dimensiones de las piezas son aproximadas, FIG S.L. no se hace responsable de problemas en la instalación de las mismas.



KIT HORIZONTALES Y CONEXIONES VERTICALES



COMPLEMENTOS



TERMINALES

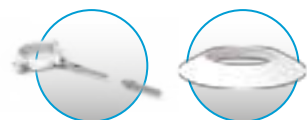

COMPLEMENTOS



RECOGE CONDENSADOS



AMPLIACIONES Y MANGUITOS



CODOS



TUBOS



TUBOS

Tubo coaxial Macho - Hembra Ø60 / Ø100(Aluminio lacado)



Acabado

CÓDIGO	Ø	LONGITUD	€/UD
610-250MHP1	Ø60 / Ø100	250 mm	15,06 €
610-500MHP1	Ø60 / Ø100	500 mm	18,53 €
610-1000MHP1	Ø60 / Ø100	1000 mm	27,12 €
610-1500MHP1	Ø60 / Ø100	1500 mm	49,72 €
610-2000MHP1	Ø60 / Ø100	2000 mm	63,25 €

Tubo coaxial Macho - Hembra Ø80 / Ø125 (Aluminio lacado)



Acabado

CÓDIGO	Ø	LONGITUD	€/UD
8125-250MHP1	Ø80 / Ø125	250 mm	18,81 €
8125-500MHP1	Ø80 / Ø125	500 mm	24,57 €
8125-1000MHP1	Ø80 / Ø125	1000 mm	38,81 €
8125-1500MHP1	Ø80 / Ø125	1500 mm	78,09 €
8125-2000MHP1	Ø80 / Ø125	2000 mm	100,64 €

CODOS

Codo coaxial 90° Macho - Hembra (Aluminio lacado)



Acabado

CÓDIGO	UNIÓN	Ø	€/UD
610-90MHP1	M-H	Ø60 / Ø100	22,89 €
8125-90MHP1	M-H	Ø80 / Ø125	36,39 €

Codo coaxial 90° Hembra - Hembra (Aluminio lacado)

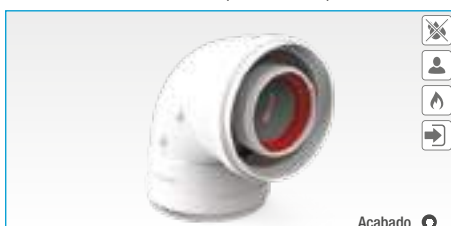

Acabado

CÓDIGO	UNIÓN	Ø	€/UD
610-90HHP1	H-H	Ø60 / Ø100	25,22 €
8125-90HHP1	H-H	Ø80 / Ø125	34,39 €

Codo coaxial 45° Macho - Hembra (Aluminio lacado)



Acabado

CÓDIGO	UNIÓN	Ø	€/UD
610-45MHP1	M-H	Ø60 / Ø100	29,15 €
8125-45MHP1	M-H	Ø80 / Ø125	33,96 €

Codo coaxial 45° Hembra- Hembra (Aluminio lacado)



Acabado

CÓDIGO	UNIÓN	Ø	€/UD
610-45HHP1	H-H	Ø60 / Ø100	27,55 €
8125-45HHP1	H-H	Ø80 / Ø125	32,09 €

RECÓGE CONDENSADOS

Manguito coaxial recoge condensados Macho - Hembra (Aluminio lacado)



Acabado

CÓDIGO	Ø	€/UD
610RCMHP1	Ø60 / Ø100	38,30 €
8125RCMHP1	Ø80 / Ø125	53,41 €

Ampliación coaxial recoge condensados Macho - Hembra (Aluminio lacado)



Acabado

CÓDIGO	Ø	€/UD
6810125AMPRCMHP1	Ø60 / Ø100 a Ø80 / Ø125	52,17 €

AMPLIACIONES Y MANGUITOS

Ampliación coaxial Macho - Hembra (Aluminio lacado)

Acabado

CÓDIGO	Ø	€/UD
6810125AMPMP1	Ø60 / Ø100 a Ø80 / Ø125	28,34 €

Manguito coaxial unión tubos Hembra - Hembra (Aluminio lacado)

Acabado

CÓDIGO	Ø	€/UD
610MTTP1	Ø60 / Ø100	11,88 €
8125MTTP1	Ø80 / Ø125	14,00 €

INSPECCIONES

Codo coaxial con toma de muestras Macho - Hembra (Aluminio lacado)

Acabado

CÓDIGO	Ø	€/UD
610-90TMMHP1	Ø60 / Ø100	39,11 €

Manguito coaxial con toma de muestras Macho - Hembra (Aluminio lacado)

Acabado

CÓDIGO	Ø	€/UD
610TMMHP1	Ø60 / Ø100	23,98 €
8125TMMHP1	Ø80 / Ø125	72,78 €

COMPLEMENTOS

Kit toma de muestras

Acabado

CÓDIGO	Ø	€/UD
610KITTP1		15,77 €

Abrazadera pared (Acero lacado)

Acabado

CÓDIGO	Ø	€/UD
10ABPRP3	Ø100	4,08 €
125ABPRP3	Ø125	4,19 €

Plafón (Silicona)

Acabado

CÓDIGO	Ø	€/UD
10PL6	Ø100	3,23 €
125PL6	Ø125	7,74 €

Junta de silicona labiada (Silicona)

Acabado

CÓDIGO	Ø	€/UD
6JTSIL	Ø60	0,58 €
8JTSIL	Ø80	0,72 €
10JTSIL	Ø100	1,05 €
127JTSIL	Ø125	1,60 €

Teja (Aluminio/PVC)

*Uso con 610ST18, 8125ST18
Acabado

CÓDIGO	Ø	€/UD
TEJA	Ø60 / Ø100 Ø80 / Ø125	53,01 €

Teja plana (PVC)

*Uso con 610ST18, 8125ST18
Acabado

CÓDIGO	Ø	€/UD
TEJAPLANAP1	Ø60 / Ø100 Ø80 / Ø125	30,32 €

TERMINALES

Terminal coaxial horizontal corto (Nylon)

Acabado

CÓDIGO	Ø	€/UD
610DFH7	Ø60 / Ø100	4,67 €

Tramo terminal coaxial horizontal orientable (Aluminio/Nylon)

Acabado

CÓDIGO	Ø	€/UD
610DFHREP14	Ø60 / Ø100	39,32 €

Salida a techo (Aluminio/PVC)

Acabado

CÓDIGO	Ø	€/UD
610ST18	Ø60 / Ø100	99,14 €
8125ST18	Ø80 / Ø125	72,78 €

Terminal coaxial vertical corto (Aluminio/PVC)

Acabado

CÓDIGO	Ø	€/UD
610DFV18	Ø60 / Ø100	25,23 €
8125DFV18	Ø80 / Ø125	57,72 €

Terminal coaxial horizontal (1 tubo terminal + 2 plafones EPDM)(Al. lacado)

Acabado

CÓDIGO	Ø	€/UD
610TDFHP17	Ø60 / Ø100	34,41 €

Terminal coaxial horizontal (1 tubo terminal + 2 plafones EPDM)(Al. lacado)

Acabado

CÓDIGO	Ø	€/UD
8125TDFHP17	Ø80 / Ø125	59,94 €

ACCESORIOS MULTICOMPATIBLES

Kit coaxial horizontal (Aluminio lacado)

Acabado

CÓDIGO	Ø	€/UD
610KCCMULTIP1	Ø60 / Ø100	60,65 €

Conexión vertical multicompatible (Aluminio lacado)

Acabado

CÓDIGO	Ø	€/UD
610CVMULTIP1	Ø60 / Ø100	52,32 €

Conexión vertical multicompatible exterior (Aluminio lacado)

Acabado

CÓDIGO	Ø	€/UD
6108CONVEXTMUP1	Ø60 / Ø100	60,65 €



PIEZAS DE Ø80 / Ø110 (COMPATIBLES CON JUNKERS)

Tubo coaxial Macho - Hembra Ø80 / Ø110 (Aluminio lacado)



CÓDIGO	Ø	LONGITUD	€/UD
811-250MHP1	Ø80 / Ø110	250 mm	17,13 €
811-500MHP1	Ø80 / Ø110	500 mm	23,05 €
811-1000MHP1	Ø80 / Ø110	1000 mm	35,02 €
811-1500MHP1	Ø80 / Ø110	1500 mm	72,61 €
811-2000MHP1	Ø80 / Ø110	2000 mm	93,10 €

Codo coaxial 90° Macho - Hembra Ø80 / Ø110 (Aluminio lacado)



CÓDIGO	UNIÓN	Ø	€/UD
811-90MHP1	M-H	Ø80 / Ø110	28,89 €

Codo coaxial 90° Hembra - Hembra Ø80 / Ø110 (Aluminio lacado)

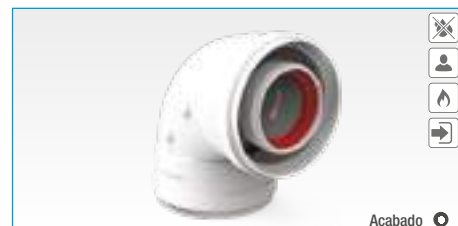

CÓDIGO	UNIÓN	Ø	€/UD
811-90HHP1	H-H	Ø80 / Ø110	28,28 €

Codo coaxial 45° Macho - Hembra Ø80 / Ø110 (Aluminio lacado)



CÓDIGO	UNIÓN	Ø	€/UD
811-45MHP1	M-H	Ø80 / Ø110	29,96 €

Codo coaxial 45° Hembra - Hembra Ø80 / Ø110 (Aluminio lacado)



CÓDIGO	UNIÓN	Ø	€/UD
811-45HHP1	H-H	Ø80 / Ø110	27,63 €

Ampliación coaxial Macho - Hembra (Aluminio lacado)



CÓDIGO	Ø	€/UD
681011AMPMPH1	Ø60/100 a Ø80/110	38,69 €

Manguito coaxial unión tubos Macho - Macho (Aluminio lacado)



CÓDIGO	Ø	€/UD
811MTTP1	Ø80 / Ø110	13,05 €

Manguito coaxial con toma de muestras Macho - Hembra (Aluminio lacado)



CÓDIGO	Ø	€/UD
811TMMHP1	Ø80 / Ø110	24,15 €

Terminal coaxial horizontal (1 tubo terminal + 2 plafones EPDM)(Al. lacado)



CÓDIGO	Ø	€/UD
811TDFHP1	Ø80 / Ø110	60,06 €

Kit coaxial horizontal (Aluminio lacado)



CÓDIGO	Ø	€/UD
811KCCJKP1	Ø80 / Ø110	80,00 €

Salida a techo (Aluminio/PVC)



CÓDIGO	Ø	€/UD
811ST18	Ø80 / Ø110	109,97 €

Terminal coaxial vertical corto (Aluminio/PVC)



CÓDIGO	Ø	€/UD
811DFV18	Ø80 / Ø110	90,09 €

Abrazadera (Aluminio lacado)



CÓDIGO	Ø	€/UD
11ABPRP3	Ø110	3,93 €

Plafón (EPDM)



CÓDIGO	Ø	€/UD
11PL6	Ø110	7,75 €

Junta (silicona)



CÓDIGO	Ø	€/UD
11JTSIL	Ø110	1,45 €

KITS HORIZONTALES COMPATIBLES

610KCCBEP1 (Aluminio lacado)



Acabado

MARCA	MODELO	Ø	€/UD
BERETTA	T/M	Ø60 / Ø100	54,61 €
VANWARDIST	TOUCH	Ø60 / Ø100	

610KCCUP1 (Aluminio lacado)



Acabado

MARCA	MODELO	Ø	€/UD
COINTRA	T/M	Ø60 / Ø100	54,61 €
FORCALI	T/M	Ø60 / Ø100	

610KCCCORBP1 (Aluminio lacado)



Acabado

MARCA	MODELO	Ø	€/UD
CORBERO	T/M	Ø60 / Ø100	51,60 €
COBETA	T/M	Ø60 / Ø100	

610KCCCALGDAP1 (Aluminio lacado)



Acabado

MARCA	MODELO	Ø	€/UD
HTV	ELITE	Ø60 / Ø100	53,61 €
	LOW NOX	Ø60 / Ø100	

610KCCSDP1 (Aluminio lacado)



Acabado

MARCA	MODELO	Ø	€/UD
SAUNIER DUVAL	OPALIA F	Ø60 / Ø100	54,61 €

610KCCVAP1 (Aluminio lacado)



Acabado

MARCA	MODELO	Ø	€/UD
SAUNIER DUVAL	OPALIA THERM	Ø60 / Ø100	53,25 €
VAILLANT	T/M	Ø60 / Ø100	

610KCCSICLP1 (Aluminio lacado)



Acabado

MARCA	MODELO	Ø	€/UD
SIME	T/M	Ø60 / Ø100	52,51 €

610KCCFAP1 (Aluminio lacado)



Acabado

MARCA	MODELO	Ø	€/UD
FAGOR	T/M	Ø60 / Ø100	54,82 €
ARISTON	T/M	Ø60 / Ø100	

610KCCFONDPI (Aluminio lacado)



Acabado

MARCA	MODELO	Ø	€/UD
FONDITAL	LIPARI TF	Ø60 / Ø100	54,61 €
BAXI	SERIA FI	Ø60 / Ø100	
CHAFFOTEAUX	AVENIR STF	Ø60 / Ø100	
THERMOR	TOP SEALED	Ø60 / Ø100	

SALIDAS VERTICALES COMPATIBLES

610CVBEP1 (Aluminio lacado)



Acabado

MARCA	MODELO	Ø	€/UD
BERETTA	T/M	Ø60 / Ø100	36,94 €
VANWARDIST	TOUCH	Ø60 / Ø100	

610CVUP1 (Aluminio lacado)



Acabado

MARCA	MODELO	Ø	€/UD
COINTRA	T/M	Ø60 / Ø100	27,20 €
FORCALI	T/M	Ø60 / Ø100	

610CVCORB1 (Aluminio lacado)



Acabado

MARCA	MODELO	Ø	€/UD
CORBERO	T/M	Ø60 / Ø100	33,26 €
COBETA	T/M	Ø60 / Ø100	

610CVCALGDAP1 (Aluminio lacado)



Acabado

MARCA	MODELO	Ø	€/UD
HTV	ELITE	Ø60 / Ø100	38,01 €
	LOW NOX	Ø60 / Ø100	

610CVSDP1 (Aluminio lacado)



Acabado

MARCA	MODELO	Ø	€/UD
SAUNIER DUVAL	OPALIA F	Ø60 / Ø100	35,32 €

610CVVAP1 (Aluminio lacado)



Acabado

MARCA	MODELO	Ø	€/UD
SAUNIER DUVAL	OPALIA THERM	Ø60 / Ø100	14,58 €
VAILLANT	T/M	Ø60 / Ø100	

610CVSICLP1 (Aluminio lacado)



Acabado

MARCA	MODELO	Ø	€/UD
SIME	T/M	Ø60 / Ø100	30,88 €

610CVCLARP1 (Aluminio lacado)



Acabado

MARCA	MODELO	Ø	€/UD
ARISTON	T/M	Ø60 / Ø100	29,16 €

610CVFAP1 (Aluminio lacado)



Acabado

MARCA	MODELO	Ø	€/UD
FAGOR	T/M	Ø60 / Ø100	36,16 €

610CVFOND1 (Aluminio lacado)



Acabado

MARCA	MODELO	Ø	€/UD
FONDITAL	LIPARI TF	Ø60 / Ø100	30,88 €
BAXI	SERIA FI	Ø60 / Ø100	
CHAFFOTEAUX	AVENIR STF	Ø60 / Ø100	
THERMOR	TOP SEALED	Ø60 / Ø100	

Keramik

CONDUCTOS Y COMPONENTES PARA EVACUACIÓN DE HUMOS DE
ESTUFAS DE PELLETS / BIOMASA



SIMPLE Y AISLADO PELLET

Conductos para evacuación de humos de combustión, en estufas y calderas de pellet en instalaciones individuales tanto en INTERIOR como en EXTERIOR.

Características:

- Material: Acero vitrificado o acero inox AISI 316
- Combustible: Pellets / Biomasa.
- Temperatura máxima: 200°C.
- Color: Negro mate.
- Unión entre piezas: Machihembrado.
- Junta de estanqueidad: Silicona de alta temperatura.
- Designación de producto:
- Acero inoxidable con junta:
 - T200-P1-D-Vm-L50050-O(40)M
- Acero vitrificado con junta:
 - T200-P1-D-Vm-L80080-O(40)M
- Acero vitrificado sin junta:
 - T200-N1-D-Vm-L80080-G(375)M
- Diámetros disponibles:
 - Pared simple: $\varnothing 80$ - $\varnothing 100$
 - Doble pared aislado: $\varnothing 80/100$ - $\varnothing 100/120$

COAXIAL

Conductos COAXIALES para evacuación de humos de combustión, en estufas y calderas de pellet en instalaciones individuales en INTERIOR.

Características:

- Material: Acero esmaltado.
- Combustible: Pellets / Biomasa.
- Temperatura máxima: 200°C.
- Color: Negro mate.
- Unión entre piezas: Machihembrado.
- Junta de estanqueidad: Silicona de alta temperatura.
- Designación de producto:
 - T200-P1-D-Vm-L50050-O(40)M
- Diámetros disponibles:
 - $\varnothing 80/130$

SIMPLE CLASSIC

Conductos para evacuación de humos de combustión, en hogares, estufas y calderas de leña en instalaciones individuales en INTERIOR.

Características:

- Material: Acero vitrificado.
- Combustible: Leña.
- Temperatura máxima: 600°C.
- Color: Negro mate.
- Unión entre piezas: Machihembrada.
- Designación de producto:
 - T600-N2-D-Vm-L80080-O(600)NM
- Diámetros disponibles:
 - $\varnothing 120$ - $\varnothing 125$ - $\varnothing 150$ - $\varnothing 180$ - $\varnothing 200$

Keramik

Pellets - Biomasa

SIMPLE Y AISLADO PELLET

Conductos para evacuación de humos de combustión, en estufas y calderas de pellet en instalaciones individuales tanto en INTERIOR como en EXTERIOR.

Características:

- Material: Acero vitrificado o acero inox AISI 316
- Combustible: Pellets / Biomasa.
- Temperatura máxima: 200°C.
- Color: Negro mate.
- Unión entre piezas: Machihembrado.
- Junta de estanqueidad: Silicona de alta temperatura.
- Designación de producto:
 - Acero inoxidable con junta:
 - T200-P1-D-Vm-L50050-O(40)M
 - Acero vitrificado con junta:
 - T200-P1-D-Vm-L80080-O(40)M
 - Acero vitrificado sin junta:
 - T200-N1-D-Vm-L80080-G(375)M
- Diámetros disponibles:
 - Pared simple: $\varnothing 80$ - $\varnothing 100$
 - Doble pared aislado: $\varnothing 80/100$ - $\varnothing 100/120$



NOTA IMPORTANTE

Limpiar el hollín del interior del conducto de humos según manual estufa.



APLICACIONES

Para instalar en el hogar, en proximidad de personas y animales empleando los módulos protegidos 80/100.

Módulos simples $\varnothing 80$, recomendados en lugares de difícil acceso de personas y animales.

Módulos aislados con lana de roca para instalaciones en el exterior de la vivienda. Accesorios de transición entre diferentes tipo de módulos y diámetros.



CALIDAD

Curvas estampadas lisas y redondeadas, sin aristas ni obstrucciones internas. Permiten un mejor paso de humos y una menor pérdida de carga. Facilitan la limpieza y acumulan menos suciedad, ocupan menos espacio respecto a los codos de gajos. Estética redondeada en armonía con el entorno de un hogar moderno. Terminal horizontal en INOX $\varnothing 80$ de rejilla con hilo fino. Evita la acumulación de residuos.



Los dibujos de las piezas son orientativos, FIG S.L. se reserva el derecho de cambiar las características de los productos sin previo aviso. Las dimensiones de las piezas son aproximadas, FIG S.L. no se hace responsable de problemas en la instalación de las mismas.



COMPLEMENTOS



TERMINALES



AMPLIACIONES, ADAPTADORES Y RECOGE CONDENSADOS



CODOS



TUBOS



CANALIZACIÓN DE AIRE



TUBOS

Tubo simple Macho - Hembra (Acero vitrificado)



Acabado

CÓDIGO	Ø	LONGITUD	€/UD
8-250MHKER3	Ø80	250 mm	15,77 €
8-500MHKER3	Ø80	500 mm	20,18 €
8-1000MHKER3	Ø80	1000 mm	21,34 €
10-250MHKER3	Ø100	250 mm	21,58 €
10-500MHKER3	Ø100	500 mm	23,33 €
10-1000MHKER3	Ø100	1000 mm	24,94 €

TUBOS TELESCÓPICOS

Tubo telescópico simple Macho - Hembra (Acero vitrificado)



Acabado

CÓDIGO	Ø	LONGITUD	€/UD
8TLKER3	Ø80	500 - 900 mm	35,97 €
10TLKER3	Ø100	500 - 900 mm	41,59 €

CODOS Y TES

Codo 90° simple Macho - Hembra (Acero vitrificado)



Acabado

CÓDIGO	Ø	€/UD
8-90MHKER3	Ø80	21,46 €
10-90MHKER3	Ø100	22,98 €

Codo 45° simple Macho - Hembra (Acero vitrificado)



Acabado

CÓDIGO	Ø	€/UD
8-45MHKER3	Ø80	20,64 €
10-45MHKER3	Ø100	23,05 €

Te recoge hollín Macho - Hembra (Acero vitrificado)



Acabado

CÓDIGO	Ø	€/UD
8TEKER3	Ø80	45,67 €
10TEKER3	Ø100	61,81 €

AMPLIACIONES Y MANGUITOS

Ampliación Macho - Hembra interior (Inox pintado anticorrosivo)



Acabado

CÓDIGO	Ø	€/UD
810AMPMPPEL4	Ø80 / Ø100	23,91 €

Manguito Macho - Macho (Inox pintado anticorrosivo)



Acabado

CÓDIGO	UNIÓN	Ø	€/UD
8-100MMPPEL4	M-M	Ø80	22,08 €
10-100MMPPEL4	M-M	Ø100	22,97 €

Manguito Hembra - Hembra (Inox pintado anticorrosivo)



Acabado

CÓDIGO	UNIÓN	Ø	€/UD
8MTTPEL4	H-H	Ø80	13,49 €
10MTTPEL4	H-H	Ø100	16,36 €

COMPLEMENTOS

Abrazadera de pared (Acero)



Acabado

CÓDIGO	Ø	€/UD
8ABPRPEL	Ø80	3,86 €
10ABPRPEL	Ø100	4,02 €
120ABPRPEL	Ø120	9,70 €

Plafón (Silicona)



CÓDIGO	Ø	€/UD
8PL6-NERO	Ø80	4,58 €
10PL6-NERO	Ø100	5,06 €
120PL6-NERO	Ø120	14,47 €

Junta de silicona labiada (Silicona altas temperaturas)



CÓDIGO	Ø	€/UD
8JTSIL	Ø80	0,72 €

Corta tiro regulable (Inox pintado anticalórico)



Acabado 

CÓDIGO	Ø	€/UD
8CORTATIROP4	Ø80	111,59 €
10CORTATIROP4	Ø100	120,08 €

TERMINALES

Deflector evacuación vertical Macho (Inox pintado anticalórico)



Acabado 

CÓDIGO	Ø	€/UD
8DFVPELP4	Ø80	33,66 €
10DFVPELP4	Ø100	32,75 €

Deflector horizontal antilluvia Macho (Inox pintado anticalórico)



Acabado 

CÓDIGO	Ø	€/UD
8DFHALLP4	Ø80	19,24 €
10DFHALLP4	Ø100	23,33 €

Deflector anti-revoque Macho (Acero vitrificado)



Acabado 

CÓDIGO	Ø	€/UD
8DFARKER3	Ø80	49,19 €
10DFARKER3	Ø100	57,87 €

Deflector salida horizontal antimanchas pared (Inox 316)



Acabado 

CÓDIGO	Ø	€/UD
8DFHPROTSP316	Ø80	92,64 €
10DFHPROTSP316	Ø100	99,46 €

Deflector evacuación salida cañón Macho (Inox pintado anticalórico)



Acabado 

CÓDIGO	Ø	€/UD
8DFHPELP4	Ø80	22,62 €

TUBOS

Tubo aislado Macho - Hembra (Inox pintado anticorrosivo)



Acabado

CÓDIGO	Ø	LONGITUD	€/UD
80-250DP316NG	Ø80	250 mm	77,63 €
80-500DP316NG	Ø80	500 mm	97,84 €
80-1000DP316NG	Ø80	1000 mm	138,46 €
100-250DP316NG	Ø100	250 mm	84,61 €
100-500DP316NG	Ø100	500 mm	109,19 €
100-1000DP316NG	Ø100	1000 mm	152,32 €

CODOS

Codo aislado 90° Macho - Hembra (Inox 316)



Acabado

CÓDIGO	Ø	€/UD
80-90DP316NG	Ø80	151,82 €
100-90DP316NG	Ø100	168,65 €

Codo aislado 45° Macho - Hembra (Inox 316)

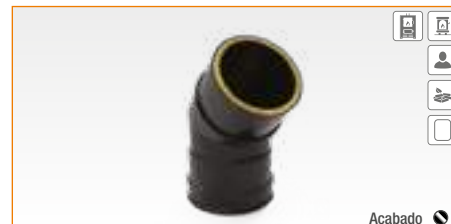

Acabado

CÓDIGO	Ø	€/UD
80-45DP316NG	Ø80	107,12 €
100-45DP316NG	Ø100	115,37 €

TES Y TAPES

Te aislada Macho - Hembra (Inox pintado anticorrosivo)



Acabado

CÓDIGO	Ø	€/UD
80-TEDP316NG	Ø80	187,45 €
100-TEDP316NG	Ø100	202,80 €

Tapa con purga (Inox pintado anticorrosivo)



Acabado

CÓDIGO	Ø	€/UD
80-TAPEDP316NG	Ø80	55,33 €
100-TAPEDP316NG	Ø100	63,25 €

ADAPTADORES

Adaptador simple pared a aislado (Inox pintado anticorrosivo)



Acabado

CÓDIGO	Ø	€/UD
80SPDP316NG	Ø80	96,29 €
100SPDP316NG	Ø100	99,91 €

Adaptador aislado a simple pared (Inox pintado anticorrosivo)



Acabado

CÓDIGO	Ø	€/UD
80DPSP316NG	Ø80	96,29 €
100DPSP316NG	Ø100	99,91 €

TERMINALES

Deflector evacuación vertical Macho (Inox pintado anticorrosivo)



Acabado

CÓDIGO	Ø	€/UD
80DFVDP316NG	Ø80	88,45 €
100DFVDP316NG	Ø100	107,64 €

CANALIZACIÓN DE AIRE

Tubo canalización aire Macho - Hembra (PP)



Acabado ●

CÓDIGO	Ø	LONGITUD	€/UD
8-500MH5-NERO	Ø80	500 mm	8,75 €
8-1000MH5-NERO	Ø80	1000 mm	13,34 €
10-500MH5-NERO	Ø100	500 mm	18,19 €
10-1000MH5-NERO	Ø100	1000 mm	24,26 €

Codo canalización aire interior Macho - Hembra (PP)



Acabado ●

CÓDIGO	Ø	ÁNGULO	€/UD
8-90MH5-NERO	Ø80	90°	8,83 €
8-45MH5-NERO	Ø80	45°	8,83 €
10-90MH5-NERO	Ø100	90°	13,34 €
10-45MH5-NERO	Ø100	45°	13,34 €

Tapón ciego (EPDM)



Acabado ●

CÓDIGO	Ø	€/UD
8TAPESIL	Ø80	6,48 €



Estos tubos deben ser utilizados exclusivamente para la canalización de aire y NO para la evacuación de humos. No situar cerca de la fuente de calor.



Keramik

Coaxial

COAXIAL

Conductos COAXIALES para evacuación de humos de combustión, en estufas y calderas de pellet en instalaciones individuales en INTERIOR.

Características:

- Material: Acero inoxidable lacado.
- Combustible: Pellets / Biomasa.
- Temperatura máxima: 200°C.
- Color: Negro mate.
- Unión entre piezas: Machihembrado.
- Junta de estanqueidad: Silicona de alta temperatura.
- Designación de producto:
 - T200-P1-D-Vm-L50050-O(40)M
- Diámetros disponibles:
 - ø80/130



NOTA IMPORTANTE

Limpiar el hollín del interior del conducto de humos según manual estufa.



Los dibujos de las piezas son orientativos, FIG S.L. se reserva el derecho de cambiar las características de los productos sin previo aviso. Las dimensiones de las piezas son aproximadas, FIG S.L. no se hace responsable de problemas en la instalación de las mismas.



COMPLEMENTOS



TERMINALES



RECOGE CONDENSADOS



CODOS



TUBOS



TUBOS

Tubo coaxial Macho - Hembra (Acero pintado anticorrosivo)



Acabado

CÓDIGO	Ø	LONGITUD	€/UD
8130-250MHKER	Ø80 / Ø130	250	90,00 €

Tubo coaxial Macho - Hembra (Acero pintado anticorrosivo)



Acabado

CÓDIGO	Ø	LONGITUD	€/UD
8130-500MHKER	Ø80 / Ø130	500	122,00 €

Tubo coaxial Macho - Hembra (Acero pintado anticorrosivo)



Acabado

CÓDIGO	Ø	LONGITUD	€/UD
8130-1000MHKER	Ø80 / Ø130	1000	160,00 €

TUBOS TELESCÓPICOS

Tubo coaxial telescópico Macho - Hembra (Acero pintado anticorrosivo)



Acabado

CÓDIGO	Ø	LONGITUD	€/UD
8130TLKER	Ø80 / Ø130	340 - 550	169,00 €

CODOS

Codo coaxial 90° Macho - Hembra (Acero pintado anticorrosivo)



Acabado

CÓDIGO	Ø	€/UD
8130-90MHKER	Ø80 / Ø130	185,00 €

Codo coaxial 45° Macho - Hembra (Acero pintado anticorrosivo)



Acabado

CÓDIGO	Ø	€/UD
8130-45MHKER	Ø80 / Ø130	130,00 €

TES Y TAPES

Te coaxial Macho - Hembra (Acero pintado anticorrosivo)



Acabado

CÓDIGO	Ø	€/UD
8130TEKER	Ø80 / Ø130	235,00 €

Tape coaxial Macho - Hembra (Acero pintado anticorrosivo)



Acabado

CÓDIGO	Ø	€/UD
8130TAPEKER	Ø80 / Ø130	171,00 €

Tramo inspección coaxial Macho - Hembra (Acero pintado anticorrosivo)



Acabado

CÓDIGO	Ø	€/UD
8130INSPKER	Ø80 / Ø130	280,00 €

ADAPTADORES

Adaptador aspiración coaxial M-H (Acero pintado anticorrosivo)



Acabado

CÓDIGO	Ø	€/UD
8130COLASPKER	Ø80 / Ø130	220,00 €

Adaptador extracción coaxial M-H (Acero pintado anticorrosivo)



Acabado

CÓDIGO	Ø	€/UD
8130COLEVAKER	Ø80 / Ø130	217,00 €

COMPLEMENTOS

Abrazadera coaxial (Acero pintado anticorrosivo)



Acabado 

CÓDIGO	Ø	€/UD
130ABPRPEL	Ø130	19,50 €

Tubo flexible para aspiración negro (PP)



Acabado 

CÓDIGO	Ø	€/UD
8FLEXKERASP	Ø80	49,00 €

TERMINALES

Deflector antirretorno coaxial (Acero pintado anticorrosivo)



Acabado 

CÓDIGO	Ø	€/UD
8130DFRHKER	Ø80 / Ø130	255,00 €

Deflector horizontal coaxial (Acero pintado anticorrosivo)



Acabado 

CÓDIGO	Ø	€/UD
8130DFHKER	Ø80 / Ø130	203,00 €

Keramik

Classic

SIMPLE CLASSIC

Conductos para evacuación de humos de combustión, en hogares, estufas y calderas de leña en instalaciones individuales en INTERIOR.

Características:

- Material: Acero vitrificado.
- Combustible: Leña.
- Temperatura máxima: 600°C.
- Color: Negro mate.
- Unión entre piezas: Machihembrada.
- Designación de producto:
 - T600-N2-D-Vm-L80080-O(600)NM
- Diámetros disponibles:
 - \varnothing 120 - \varnothing 125 - \varnothing 150 - \varnothing 180 - \varnothing 200



NOTA IMPORTANTE

Limpiar el hollín del interior del conducto de humos según manual estufa.



Para instalar en el hogar. Módulos simples de diámetro 120 a 200 en estufas y calderas de leña.



Los dibujos de las piezas son orientativos, FIG S.L. se reserva el derecho de cambiar las características de los productos sin previo aviso. Las dimensiones de las piezas son aproximadas, FIG S.L. no se hace responsable de problemas en la instalación de las mismas.



COMPLEMENTOS



TERMINALES



RECOGE CONDENSADOS Y CORTATIROS



ADAPTADORES Y AMPLIACIONES



TUBOS Y CODOS



TUBOS

Tubo (Acero vitrificado mate)



Acabado

CÓDIGO	Ø	LONGITUD	€/UD
120-500MHKCLMA3	Ø120	500 mm	30,55 €
125-500MHKCLMA3	Ø125	500 mm	33,42 €
150-500MHKCLMA3	Ø150	500 mm	34,07 €
180-500MHKCLMA3	Ø180	500 mm	40,78 €
200-500MHKCLMA3	Ø200	500 mm	45,29 €

Tubo (Acero vitrificado mate)



Acabado

CÓDIGO	Ø	LONGITUD	€/UD
120-1000MHKCLMA3	Ø120	1000 mm	37,83 €
125-1000MHKCLMA3	Ø125	1000 mm	40,11 €
150-1000MHKCLMA3	Ø150	1000 mm	44,79 €
180-1000MHKCLMA3	Ø180	1000 mm	50,80 €
200-1000MHKCLMA3	Ø200	1000 mm	60,16 €

Deslizante (Acero vitrificado mate)



Acabado

CÓDIGO	Ø	€/UD
120TLKCLMA3	Ø120	41,41 €
125TLKCLMA3	Ø125	42,71 €
150TLKCLMA3	Ø150	50,47 €
180TLKCLMA3	Ø180	59,53 €
200TLKCLMA3	Ø200	59,53 €

CODOS

Codo 90° simple Macho - Hembra (Acero vitrificado mate)



Acabado

CÓDIGO	Ø	€/UD
120-90MHKCLMA3	Ø120	39,36 €
125-90MHKCLMA3	Ø125	42,71 €
150-90MHKCLMA3	Ø150	43,05 €
180-90MHKCLMA3	Ø180	55,65 €
200-90MHKCLMA3	Ø200	58,24 €

Codo 45° simple Macho - Hembra (Acero vitrificado mate)



Acabado

CÓDIGO	Ø	€/UD
120-45MHKCLMA3	Ø120	33,11 €
125-45MHKCLMA3	Ø125	35,03 €
150-45MHKCLMA3	Ø150	38,77 €
180-45MHKCLMA3	Ø180	46,59 €
200-45MHKCLMA3	Ø200	45,51 €

TES Y TAPES

Te 90° con tapa (Acero vitrificado mate)



Acabado

CÓDIGO	Ø	€/UD
120TEKCLMA3	Ø120	57,49 €
125TEKCLMA3	Ø125	60,16 €
150TEKCLMA3	Ø150	64,17 €
180TEKCLMA3	Ø180	77,54 €
200TEKCLMA3	Ø200	84,22 €

Tapa (Acero vitrificado mate)



Acabado

CÓDIGO	Ø	€/UD
120TAPEKCLMA3	Ø120	33,42 €
125TAPEKCLMA3	Ø125	35,87 €
150TAPEKCLMA3	Ø150	38,63 €
180TAPEKCLMA3	Ø180	48,29 €
200TAPEKCLMA3	Ø200	49,67 €

AMPLIACIONES Y MANGUITOS

Ampliación (Acero vitrificado mate)



Acabado

CÓDIGO	Ø	€/UD
120150AMPKCLMA3	Ø120/Ø150	44,28 €
125150AMPKCLMA3	Ø125/Ø150	46,74 €
150180AMPKCLMA3	Ø150/Ø180	59,04 €
150200AMPKCLMA3	Ø150/Ø200	61,50 €
180200AMPKCLMA3	Ø180/Ø200	55,35 €

Manguito unión Macho - Macho (Acero vitrificado mate)



Acabado

CÓDIGO	UNIÓN	Ø	€/UD
120MMKCLMA3	M-M	Ø120	28,97 €
125MMKCLMA3	M-M	Ø125	28,00 €
150MMKCLMA3	M-M	Ø150	30,55 €
180MMKCLMA3	M-M	Ø180	33,09 €
200MMKCLMA3	M-M	Ø200	36,91 €

Manguito unión Hembra - Hembra (Acero vitrificado mate)



Acabado

CÓDIGO	UNIÓN	Ø	€/UD
120HHKCLMA3	H-H	Ø120	26,73 €
125HHKCLMA3	H-H	Ø125	28,00 €
150HHKCLMA3	H-H	Ø150	30,55 €
180HHKCLMA3	H-H	Ø180	33,09 €
200HHKCLMA3	H-H	Ø200	40,01 €

COMPLEMENTOS

Tubo con cortatiro (Acero vitrificado mate)



Acabado

CÓDIGO	Ø	€/UD
120CTKCLMA3	Ø120	57,27 €
125CTKCLMA3	Ø125	59,51 €
150CTKCLMA3	Ø150	64,09 €
180CTKCLMA3	Ø180	73,24 €
200CTKCLMA3	Ø200	77,82 €

Abrazadera (Acero vitrificado mate)



Acabado

CÓDIGO	Ø	€/UD
120APRKCLMA3	Ø120	24,73 €
125APRKCLMA3	Ø125	25,40 €
150APRKCLMA3	Ø150	25,40 €
180APRKCLMA3	Ø180	27,41 €
200APRKCLMA3	Ø200	28,07 €

Plafón (Acero vitrificado mate)



Acabado

CÓDIGO	Ø	€/UD
120PLKCLMA3	Ø120	19,06 €
125PLKCLMA3	Ø125	19,06 €
150PLKCLMA3	Ø150	23,37 €
180PLKCLMA3	Ø180	26,44 €
200PLKCLMA3	Ø200	26,44 €

TERMINALES

Sobrero antilluvia "Seta" (Acero vitrificado mate)



Acabado

CÓDIGO	Ø	€/UD
120DFVKCLMA3	Ø120	46,79 €
125DFVKCLMA3	Ø125	48,13 €
150DFVKCLMA3	Ø150	52,14 €
180DFVKCLMA3	Ø180	68,18 €
200DFVKCLMA3	Ø200	70,86 €

Antirrevocante (Acero vitrificado mate)



Acabado

CÓDIGO	Ø	€/UD
120DFVARKCLMA3	Ø120	63,47 €
125DFVARKCLMA3	Ø125	66,22 €
150DFVARKCLMA3	Ø150	73,12 €
180DFVARKCLMA3	Ø180	82,78 €
200DFVARKCLMA3	Ø200	89,68 €

ChimeNOX[®]

CONDUCTOS Y COMPONENTES PARA APARATOS TRADICIONALES EN
INSTALACIONES INDIVIDUALES Y COLECTIVAS



SIMPLE PARED (Inox 316)

Conductos para evacuación de humos de combustión de hogares, calderas de condensación y biomasa en instalaciones individuales o colectivas en INTERIOR y en exterior por patios interiores sujetos a la normativa vigente.

Características:

- Material: Acero inoxidable AISI 316.
- Espesor mínimo: 0,4 mm.
- Combustible Gas, gasoil, leña y biomasa.
- Temperatura máxima:
 - 200°C con junta. / 600°C sin junta.
- Unión entre piezas: Machihembrada.
- Color: Acero inox.
- Junta de estanqueidad: Silicona.
- Designación de producto:
 - Sistema con junta:
 - EN1856-1-T200-P1-W-V2-L50050-O(50)
 - Sistema con junta:
 - EN1856-2-T200-P1-W-V2-L50050-O(50)M
 - Sistema sin junta:
 - EN1856-2-T600-N1-W-V2-L50050-G(600)M
- Diámetros disponibles:
 - ø80 - ø100 - ø120 - ø130 - ø150 - ø180 - ø200 - ø250 - ø300 - ø350 - ø400 - ø450 - ø500 - ø550 - ø600 - Otros Ø consultar

Coaxial (Inox 316/304)

Conductos COAXIALES para evacuación de humos de combustión, en estufas y calderas de pellet en instalaciones individuales en INTERIOR.

Características:

- Material: Acero inox 316 interior / 304 exterior.
- Combustible: Pellets / Biomasa.
- Temperatura máxima: 200°C.
- Color: Negro mate.
- Unión entre piezas: Machihembrado.
- Junta de estanqueidad: Silicona de alta temperatura.
- Designación de producto:
 - T200-P1-D-Vm-L50050-O(40)M
- Diámetros disponibles:
 - ø80/ø130
 - ø100/ø150
 - ø130/ø200

FLEXIBLE (Interior liso 316)

Conductos FLEXIBLES con interior liso para evacuación de humos de combustión de hogares y calderas de gas o gasoil en instalaciones individuales o colectivas en INTERIOR.

Características:

- Material: Acero inoxidable AISI 316.
- Combustible: Leña, biomasa, gas o gasoil.
- Temperatura máxima:
 - 200°C con junta.
 - 600°C sin junta.
- Unión entre piezas: Machihembrada.
- Color: Acero inox.
- Junta de estanqueidad: Silicona.
- Designación de producto:
 - Sistema con junta:
 - EN1856-2-T200-P1-W-Vm-L50010-O
 - Sistema sin junta:
 - EN1856-2-T450-N1-W-Vm-L50010-G
- Diámetros disponibles:
 - ø100 - ø130 - ø150 - ø180 - ø200 - ø250 - ø300

ChimeNOX[®]

Instalaciones individuales

SIMPLE PARED (Inox 316)

Conductos para evacuación de humos de combustión de hogares, calderas de condensación y biomasa en instalaciones individuales o colectivas en INTERIOR y en exterior por patios interiores sujetos a la normativa vigente.

Características:

- Material: Acero inoxidable AISI 316.
- Espesor mínimo: 0,4 mm.
- Combustible Gas, gasoil, leña y biomasa.
- Temperatura máxima:
 - 200°C con junta. / 600°C sin junta.
- Unión entre piezas: Machihembrada.
- Color: Acero inox.
- Junta de estanqueidad: Silicona.
- Designación de producto:
 - Sistema con junta:
 - EN1856-1-T200-P1-W-V2-L50050-O(50)
 - Sistema con junta:
 - EN1856-2-T200-P1-W-V2-L50050-O(50)M
 - Sistema sin junta:
 - EN1856-2-T600-N1-W-V2-L50050-G(600)M
- Diámetros disponibles:
 - ø80 - ø100 - ø120 - ø130 - ø150 - ø180 - ø200 - ø250 - ø300 - ø350 - ø400 - ø450 - ø500 - ø550 - ø600 -
Otros Ø consultar



Los dibujos de las piezas son orientativos, FIG S.L. se reserva el derecho de cambiar las características de los productos sin previo aviso.
Las dimensiones de las piezas son aproximadas, FIG S.L. no se hace responsable de problemas en la instalación de las mismas.



TERMINALES



COMPLEMENTOS



ADAPTADORES



RECOGE CONDENSADOS



CODOS

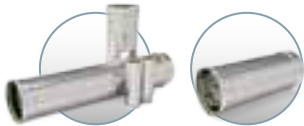

TUBOS



TUBOS

Tubo Macho - Hembra (Acero Inox 316)

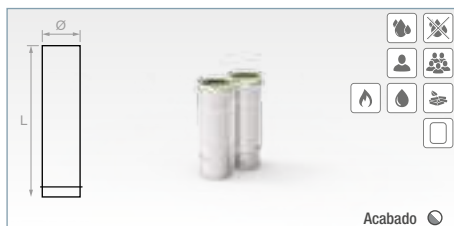

CÓDIGO	Ø	LONGITUD	€/UD
8-250SP316	80	250	16,95 €
10-250SP316	100	250	19,04 €
120-250SP316	120	250	19,83 €
130-250SP316	130	250	29,32 €
150-250SP316	150	250	29,58 €
180-250SP316	180	250	35,71 €
200-250SP316	200	250	39,02 €
250-250SP316	250	250	48,73 €
300-250SP316	300	250	61,10 €
350-250SP316	350	250	72,14 €
400-250SP316	400	250	77,48 €
450-250SP316	450	250	86,14 €
500-250SP316	500	250	93,30 €
550-250SP316	550	250	176,46 €
600-250SP316	600	250	187,76 €

Tubo Macho - Hembra (Acero Inox 316)



CÓDIGO	Ø	LONGITUD	€/UD
8-500SP316	80	500	20,03 €
10-500SP316	100	500	23,64 €
120-500SP316	120	500	27,99 €
130-500SP316	130	500	33,14 €
150-500SP316	150	500	36,38 €
180-500SP316	180	500	43,83 €
200-500SP316	200	500	48,07 €
250-500SP316	500	500	60,43 €
300-500SP316	300	500	71,73 €
350-500SP316	350	500	84,59 €
400-500SP316	400	500	95,57 €
450-500SP316	450	500	104,97 €
500-500SP316	500	500	128,29 €
550-500SP316	550	500	207,83 €
600-500SP316	600	500	221,07 €

Tubo Macho - Hembra (Acero Inox 316)



CÓDIGO	Ø	LONGITUD	€/UD
8-1000SP316	80	1000	31,18 €
10-1000SP316	100	1000	35,39 €
120-1000SP316	120	1000	42,13 €
130-1000SP316	130	1000	48,70 €
150-1000SP316	150	1000	54,29 €
180-1000SP316	180	1000	65,23 €
200-1000SP316	200	1000	71,80 €
250-1000SP316	1000	1000	91,16 €
300-1000SP316	300	1000	109,88 €
350-1000SP316	350	1000	129,27 €
400-1000SP316	400	1000	146,64 €
450-1000SP316	450	1000	164,92 €
500-1000SP316	500	1000	192,44 €
550-1000SP316	550	1000	299,39 €
600-1000SP316	600	1000	318,24 €

TUBOS TELESCÓPICOS

Tubo telescópico corto (Acero Inox 316)



CÓDIGO	Ø	L. MÁX.	L. MIN.	€/UD
80TLSP316	80	450	250	32,62 €
100TLSP316	100	450	250	38,15 €
120TLSP316	120	450	250	45,91 €
130TLSP316	130	450	250	47,21 €
150TLSP316	150	450	250	50,45 €
180TLSP316	180	450	250	60,75 €
200TLSP316	200	450	250	65,98 €
250TLSP316	250	450	250	81,18 €
300TLSP316	300	450	250	93,49 €
350TLSP316	350	450	250	111,97 €
400TLSP316	400	450	250	125,54 €
450TLSP316	450	450	250	164,92 €
500TLSP316	500	450	250	186,68 €
550TLSP316	550	450	250	262,48 €
600TLSP316	600	450	250	294,12 €



CODOS

Codo 90° (Acero Inox 316)



CÓDIGO	Ø	A	B	€/UD
8-90SP316	80	187	94	29,74 €
10-90SP316	100	197	94	33,24 €
120-90SP316	120	235	116	37,32 €
130-90SP316	130	242	130	43,18 €
150-90SP316	150	252	125	47,06 €
180-90SP316	180	283	146	59,38 €
200-90SP316	200	307	155	65,15 €
250-90SP316	250	354	176	80,69 €
300-90SP316	300	413	209	98,46 €
350-90SP316	350	480	224	132,31 €
400-90SP316	400	530	249	150,05 €
450-90SP316	450	580	274	174,95 €
500-90SP316	500	630	308	198,27 €
550-90SP316	550	680	342	327,68 €
600-90SP316	600	730	376	378,82 €

Codo 45° (Acero Inox 316)



CÓDIGO	Ø	A	B	€/UD
8-45SP316	80	105	29	22,11 €
10-45SP316	100	105	32	25,05 €
120-45SP316	120	112	35	32,48 €
130-45SP316	130	119	37	32,73 €
150-45SP316	150	125	40	35,27 €
180-45SP316	180	135	44	43,74 €
200-45SP316	200	144	47	48,71 €
250-45SP316	250	177	54	60,03 €
300-45SP316	300	173	62	91,05 €
350-45SP316	350	338	69	105,40 €
400-45SP316	400	412	76	119,33 €
450-45SP316	450	436	84	128,29 €
500-45SP316	500	471	91	139,96 €
550-45SP316	550	496	98	265,89 €
600-45SP316	600	521	105	288,79 €

Codo 30° (Acero Inox 316)



CÓDIGO	Ø	A	B	€/UD
8-30SP316	80	125	18	22,16 €
10-30SP316	100	137	19	24,96 €
120-30SP316	120	150	20	30,17 €
130-30SP316	130	151	21	31,55 €
150-30SP316	150	163	22	34,36 €
180-30SP316	180	179	24	40,82 €
200-30SP316	200	183	26	44,32 €
250-30SP316	250	212	29	52,48 €
300-30SP316	300	237	33	64,15 €
350-30SP316	350	278	36	81,64 €
400-30SP316	400	294	39	93,30 €
450-30SP316	450	323	43	139,96 €
500-30SP316	500	353	46	157,45 €
550-30SP316	550	383	49	210,19 €
600-30SP316	600	413	53	228,36 €

Codo 15° (Acero Inox 316)



CÓDIGO	Ø	A	B	€/UD
8-15SP316	80	113	7	26,33 €
10-15SP316	100	121	8	29,79 €
120-15SP316	120	124	8	31,65 €
130-15SP316	130	126	9	32,92 €
150-15SP316	150	133	9	38,42 €
180-15SP316	180	136	10	46,94 €
200-15SP316	200	144	10	50,50 €
250-15SP316	250	154	11	62,06 €
300-15SP316	300	172	12	80,68 €
350-15SP316	350	181	12	102,11 €
400-15SP316	400	186	13	115,94 €
450-15SP316	450	192	14	134,12 €
500-15SP316	500	199	15	145,79 €
550-15SP316	550	206	16	183,91 €
600-15SP316	600	213	17	199,81 €

Codo orientable (Acero Inox 316)



CÓDIGO	Ø	L	€/UD
8-CORIENTSP316	80	200	59,58 €
10-CORIENTSP316	100	210	66,12 €
120-CORIENTSP316	120	230	70,75 €
130-CORIENTSP316	130	240	75,40 €
150-CORIENTSP316	150	250	89,37 €
180-CORIENTSP316	180	290	110,20 €
200-CORIENTSP316	200	290	126,60 €
250-CORIENTSP316	250	430	143,98 €
300-CORIENTSP316	300	450	175,01 €
350-CORIENTSP316	350	470	183,70 €

TES

Te 90° sin tapón (Acero Inox 316)



CÓDIGO	Ø	A	B	€/UD
8TE90SP316	80	270	70	38,02 €
10TE90SP316	100	270	80	43,05 €
120TE90SP316	120	270	90	50,89 €
130TE90SP316	130	270	95	63,07 €
150TE90SP316	150	270	105	70,32 €
180TE90SP316	180	440	120	81,95 €
200TE90SP316	200	440	130	96,53 €
250TE90SP316	250	440	155	117,26 €
300TE90SP316	300	440	180	136,38 €
350TE90SP316	350	490	205	178,34 €
400TE90SP316	400	540	230	190,48 €
450TE90SP316	450	590	255	201,25 €
500TE90SP316	500	640	280	231,39 €
550TE90SP316	550	690	305	495,73 €
600TE90SP316	600	740	330	548,24 €

Te 45° sin tapón (Acero Inox 316)



CÓDIGO	Ø	A	B	C	€/UD
8TE45SP316	80	338	119	71	76,95 €
10TE45SP316	100	338	139	89	78,86 €
120TE45SP316	120	338	142	82	85,50 €
130TE45SP316	130	421	160	95	104,52 €
150TE45SP316	150	449	177	102	127,22 €
180TE45SP316	180	492	203	113	147,99 €
200TE45SP316	200	520	220	120	161,34 €
250TE45SP316	250	591	262	137	182,52 €
300TE45SP316	300	661	305	155	238,93 €
350TE45SP316	350	732	348	173	282,91 €
400TE45SP316	400	803	391	190	322,26 €
450TE45SP316	450	873	433	208	350,00 €
500TE45SP316	500	944	476	226	380,00 €
550TE45SP316	550	1015	519	244	446,90 €
600TE45SP316	600	1086	562	262	634,24 €

Tape con purga (Acero Inox 316)



CÓDIGO	Ø	A	B	€/UD
8TAPECONDSP316	80	96	1/2"	25,91 €
10TAPECONDSP316	100	96	1/2"	27,93 €
120TAPECONDSP316	120	96	1/2"	37,24 €
130TAPECONDSP316	130	96	1/2"	35,43 €
150TAPECONDSP316	150	96	1/2"	36,75 €
180TAPECONDSP316	180	96	1/2"	43,47 €
200TAPECONDSP316	200	96	1/2"	46,24 €
250TAPECONDSP316	250	96	1/2"	54,01 €
300TAPECONDSP316	300	96	1/2"	63,33 €
350TAPECONDSP316	350	96	1/2"	72,74 €
400TAPECONDSP316	400	96	1/2"	82,90 €
450TAPECONDSP316	450	96	1/2"	109,72 €
500TAPECONDSP316	500	96	1/2"	123,63 €
550TAPECONDSP316	550	96	1/2"	159,41 €
600TAPECONDSP316	600	96	1/2"	184,80 €

COLECTORES Y CORTATIROS

Colector vertical entronque Ø80 (Acero Inox 316)



CÓDIGO	Ø	A	B	C	€/UD
8100COLVERTSP316	100	270	80	80	51,32 €
8120COLVERTSP316	120	270	90	80	55,98 €
8130COLVERTSP316	130	270	95	80	61,81 €
8150COLVERTSP316	150	270	105	80	65,31 €
8180COLVERTSP316	180	270	120	80	78,14 €
8200COLVERTSP316	200	270	130	80	81,64 €
8250COLVERTSP316	250	270	155	80	104,97 €
8300COLVERTSP316	300	270	180	80	115,46 €
8350COLVERTSP316	350	270	205	80	145,79 €
8400COLVERTSP316	400	270	230	80	163,28 €

Cortatiros (Acero Inox 316)



CÓDIGO	Ø	L	€/UD
8CORTATSP316	100	270	consultar
10CORTATSP316	120	270	consultar
120CORTATSP316	130	270	consultar
130CORTATSP316	150	270	consultar
150CORTATSP316	180	270	consultar
180CORTATSP316	200	270	consultar
200CORTATSP316	250	270	consultar
250CORTATSP316	300	270	consultar
300CORTATSP316	350	270	consultar

INSPECCIONES

Tramo inspección (Acero Inox 316)



CÓDIGO	Ø	A	B	€/UD
8INSPSP316	80	270	130	71,97 €
10INSPSP316	100	270	140	79,52 €
120INSPSP316	120	270	150	82,22 €
130INSPSP316	130	270	155	83,14 €
150INSPSP316	150	270	165	88,26 €
180INSPSP316	180	440	180	114,86 €
200INSPSP316	200	440	190	118,49 €
250INSPSP316	250	440	215	141,51 €
300INSPSP316	300	440	240	160,81 €
350INSPSP316	350	440	265	204,80 €
400INSPSP316	400	440	290	234,59 €
450INSPSP316	450	440	315	251,96 €
500INSPSP316	500	440	340	270,58 €
550INSPSP316	550	440	365	602,13 €
600INSPSP316	600	440	390	696,21 €

Módulo toma muestra (Acero Inox 316)



CÓDIGO	Ø	A	€/UD
8TMSP316	80	190	40,51 €
10TMSP316	100	190	43,60 €
120TMSP316	120	190	49,07 €
130TMSP316	130	190	51,59 €
150TMSP316	150	190	56,52 €
180TMSP316	180	190	62,30 €
200TMSP316	200	190	65,11 €
250TMSP316	500	190	71,35 €
300TMSP316	300	190	77,20 €
350TMSP316	350	190	85,51 €
400TMSP316	400	190	93,83 €
450TMSP316	450	190	105,71 €
500TMSP316	500	190	117,28 €
550TMSP316	550	190	146,43 €
600TMSP316	600	190	177,19 €

ADAPTADORES

Adaptador Macho - Macho (Acero Inox 316)



CÓDIGO	Ø	A	€/UD
8ADPMMSP316	80	130	9,74 €
10ADPMMSP316	100	130	10,39 €
120ADPMMSP316	120	130	11,90 €
130ADPMMSP316	130	130	12,24 €
150ADPMMSP316	150	130	13,36 €
180ADPMMSP316	180	130	15,42 €
200ADPMMSP316	200	130	16,02 €
250ADPMMSP316	250	130	18,72 €
300ADPMMSP316	300	130	20,68 €
350ADPMMSP316	350	130	45,28 €
400ADPMMSP316	400	130	49,26 €
450ADPMMSP316	450	130	54,19 €
500ADPMMSP316	500	130	62,69 €
550ADPMMSP316	550	130	83,15 €
600ADPMMSP316	600	130	96,52 €

Adaptador Hembra - Hembra (Acero Inox 316)



CÓDIGO	Ø	A	€/UD
8ADPHHSP316	80	130	9,93 €
10ADPHHSP316	100	130	23,68 €
120ADPHHSP316	120	130	26,07 €
130ADPHHSP316	130	130	27,31 €
150ADPHHSP316	150	130	29,79 €
180ADPHHSP316	180	130	34,75 €
200ADPHHSP316	200	130	37,24 €
250ADPHHSP316	1000	130	48,41 €
300ADPHHSP316	300	130	53,37 €
350ADPHHSP316	350	130	81,05 €
400ADPHHSP316	400	130	88,70 €
450ADPHHSP316	450	130	99,68 €
500ADPHHSP316	500	130	117,91 €
550ADPHHSP316	550	130	154,68 €
600ADPHHSP316	600	130	215,63 €

COMPLEMENTOS

Juntas para repuestos



CÓDIGO	Ø	€/UD
10JTSPDPSIL	100	1,93 €
130JTSPDPSIL	130	2,70 €
150JTSPDPSIL	150	3,71 €
180JTSPDPSIL	180	5,29 €
200JTSPDPSIL	200	6,05 €
250JTSPDPSIL	250	9,35 €
300JTSPDPSIL	300	11,14 €
350JTSPDPSIL	350	18,57 €
400JTSPDPSIL	400	21,23 €
450JTSPDPSIL	450	23,52 €
500JTSPDPSIL	500	25,95 €

Soporte chimenea alta carga (Acero Inox 316)



CÓDIGO	Ø	A	□B	€/UD
8SOPCHISP316	80	140	180	49,21 €
10SOPCHISP316	100	140	200	52,19 €
120SOPCHISP316	120	140	220	55,83 €
130SOPCHISP316	130	140	230	58,31 €
150SOPCHISP316	150	140	250	68,88 €
180SOPCHISP316	180	140	280	74,76 €
200SOPCHISP316	200	140	300	85,50 €
250SOPCHISP316	250	140	350	113,65 €
300SOPCHISP316	300	140	400	130,13 €
350SOPCHISP316	350	140	450	157,28 €
400SOPCHISP316	400	140	500	219,22 €
450SOPCHISP316	450	140	550	259,60 €
500SOPCHISP316	500	140	600	315,18 €
550SOPCHISP316	550	140	650	355,78 €
600SOPCHISP316	600	140	700	353,00 €

Base (Acero Inox 316)



CÓDIGO	Ø	A	□B	€/UD
8BASEACSP316	80	100	180	55,85 €
10BASEACSP316	100	100	200	59,58 €
120BASEACSP316	120	100	220	64,54 €
130BASEACSP316	130	100	230	69,51 €
150BASEACSP316	150	100	250	74,47 €
180BASEACSP316	180	100	280	81,92 €
200BASEACSP316	200	100	300	88,13 €
250BASEACSP316	250	100	350	115,43 €
300BASEACSP316	300	100	400	132,81 €
350BASEACSP316	350	100	450	186,18 €
400BASEACSP316	400	100	500	243,87 €
450BASEACSP316	450	100	550	291,33 €
500BASEACSP316	500	100	600	322,16 €
550BASEACSP316	550	100	650	334,17 €
600BASEACSP316	600	100	700	345,07 €

Escuadras soporte y base alta carga (dos unidades) (Acero Inox 316)



CÓDIGO	Ø	€/UD
8KITESCUADRAS	80	34,22 €
10KITESCUADRAS	100	34,70 €
120KITESCUADRAS	120	38,09 €
130KITESCUADRAS	130	40,70 €
150KITESCUADRAS	150	43,32 €
180KITESCUADRAS	180	47,76 €
200KITESCUADRAS	200	56,32 €
250KITESCUADRAS	250	83,55 €
300KITESCUADRAS	300	99,39 €
350KITESCUADRAS	350	151,85 €
400KITESCUADRAS	400	183,65 €
450KITESCUADRAS	450	206,68 €
500KITESCUADRAS	500	245,56 €
550KITESCUADRAS	550	255,94 €
600KITESCUADRAS	600	316,98 €

Vierteaguas (Acero Inox 304)



CÓDIGO	Ø	Ø1	€/UD
8VIERTEAGUASP	80	180	28,36 €
10VIERTEAGUASP	100	200	28,49 €
120VIERTEAGUASP	120	220	29,47 €
130VIERTEAGUASP	130	230	29,79 €
150VIERTEAGUASP	150	250	28,89 €
180VIERTEAGUASP	180	280	29,43 €
200VIERTEAGUASP	200	300	33,79 €
250VIERTEAGUASP	250	350	34,34 €
300VIERTEAGUASP	300	400	35,97 €
350VIERTEAGUASP	350	450	38,15 €
400VIERTEAGUASP	400	500	43,60 €
450VIERTEAGUASP	450	550	50,14 €
500VIERTEAGUASP	500	600	54,61 €
550VIERTEAGUASP	550	650	119,28 €
600VIERTEAGUASP	600	700	131,94 €

Teja de 5° a 25 (Acero Inox 304)



CÓDIGO	Ø	A	B	€/UD
8TEJA30SP304	110	175	625	80,68 €
10TEJA30SP304	130	175	625	81,92 €
120TEJA30SP304	150	175	625	82,54 €
130TEJA30SP304	160	175	625	79,58 €
150TEJA30SP304	180	175	625	85,02 €
180TEJA30SP304	210	175	625	86,11 €
200TEJA30SP304	230	190	750	122,08 €
250TEJA30SP304	280	190	750	119,90 €
300TEJA30SP304	330	200	850	155,87 €
350TEJA30SP304	380	200	850	158,05 €
400TEJA30SP304	430	200	850	185,30 €
450TEJA30SP304	480	250	950	218,00 €
500TEJA30SP304	530	250	950	268,10 €
550TEJA30SP304	580	250	950	630,74 €
600TEJA30SP304	630	250	950	652,35 €

Teja plana (Acero Inox 304)

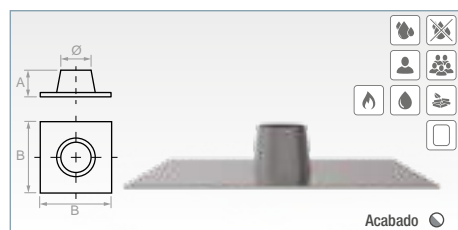

CÓDIGO	Ø	A	B	€/UD
8TEJASP304	110	175	625	78,39 €
10TEJASP304	130	175	625	79,58 €
120TEJASP304	150	175	625	80,47 €
130TEJASP304	160	175	625	81,64 €
150TEJASP304	180	175	625	85,02 €
180TEJASP304	210	175	625	86,11 €
200TEJASP304	230	190	750	119,90 €
250TEJASP304	280	190	750	119,90 €
300TEJASP304	330	200	850	158,05 €
350TEJASP304	380	200	850	163,28 €
400TEJASP304	430	200	850	179,85 €
450TEJASP304	480	250	950	212,55 €
500TEJASP304	530	250	950	266,86 €
550TEJASP304	580	250	950	548,35 €
600TEJASP304	630	250	950	553,85 €

Abrazadera descenso (Acero Inox 304)



CÓDIGO	Ø	A	€/UD
8ABRADESC304	80	170	17,66 €
10ABRADESC304	100	190	18,16 €
120ABRADESC304	120	210	19,04 €
130ABRADESC304	130	220	19,36 €
150ABRADESC304	150	240	21,15 €
180ABRADESC304	180	270	21,84 €
200ABRADESC304	200	290	22,63 €
250ABRADESC304	250	340	24,23 €
300ABRADESC304	300	390	25,10 €
350ABRADESC304	350	440	26,01 €
400ABRADESC304	400	490	27,19 €
450ABRADESC304	450	540	29,18 €
500ABRADESC304	500	590	30,32 €
550ABRADESC304	550	640	41,49 €
600ABRADESC304	600	690	54,56 €

Tubo coaxial Macho - Hembra Ø60 / Ø100(Aluminio lacado)



CÓDIGO	Ø	A	€/UD
8ABRVIENTSP304	80	120	17,42 €
10ABRVIENTSP304	100	140	17,42 €
120ABRVIENTSP304	120	160	17,72 €
130ABRVIENTSP304	130	170	18,25 €
150ABRVIENTSP304	150	190	19,62 €
180ABRVIENTSP304	180	220	20,71 €
200ABRVIENTSP304	200	240	20,71 €
250ABRVIENTSP304	250	260	23,98 €
300ABRVIENTSP304	300	290	23,66 €
350ABRVIENTSP304	350	340	25,62 €
400ABRVIENTSP304	400	390	32,70 €
450ABRVIENTSP304	450	440	35,97 €
500ABRVIENTSP304	500	490	38,07 €
550ABRVIENTSP304	550	540	47,73 €
600ABRVIENTSP304	600	590	49,05 €

Abrazadera pared (Acero Inox 304)



CÓDIGO	Ø	€/UD
8ABRSP304	80	7,58 €
10ABRSP304	100	8,16 €
120ABRSP304	120	8,75 €
130ABRSP304	130	9,33 €
150ABRSP304	150	9,91 €
180ABRSP304	180	11,08 €
200ABRSP304	200	11,66 €

Alargador soporte mural (Acero)



CÓDIGO	LONGITUD	€/UD
105ALARGADOR	105	21,83 €
205ALARGADOR	205	29,11 €

Soporte Mural (Acero Inox 304)

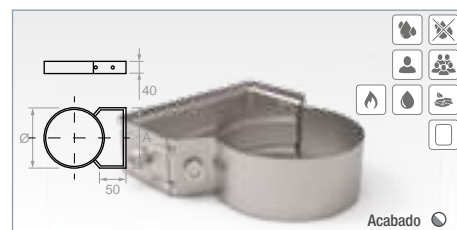

CÓDIGO	Ø	A	€/UD
8SOPMURSP304	80	102	15,75 €
10SOPMURSP304	100	116	16,91 €
125SOPMURSP304	130	130	18,08 €
130SOPMURSP304	130	137	18,66 €
150SOPMURSP304	150	152	20,81 €
180SOPMURSP304	180	172	20,99 €
200SOPMURSP304	200	188	22,89 €
250SOPMURSP304	250	223	23,98 €
300SOPMURSP304	300	259	28,34 €
350SOPMURSP304	350	293	32,75 €
400SOPMURSP304	400	328	39,24 €
450SOPMURSP304	450	364	46,87 €
500SOPMURSP304	500	399	86,88 €
550SOPMURSP304	550	424	110,21 €
600SOPMURSP304	600	448	137,76 €

TERMINALES

Deflector horizontal antilluvia (Acero Inox 316)



CÓDIGO	Ø	A	€/UD
80DFHALLSP316	80	80	41,84 €
10DFHALLSP316	100	80	43,02 €
120DFHALLSP316	120	80	45,09 €
130DFHALLSP316	130	80	45,55 €
150DFHALLSP316	150	80	46,43 €
180DFHALLSP316	180	80	56,40 €
200DFHALLSP316	200	80	60,00 €
250DFHALLSP316	250	80	63,66 €
300DFHALLSP316	300	80	82,46 €

TERMINALES

Deflector vertical antirrevoque (Acero Inox 316)



CÓDIGO	Ø	Ø1	A	€/UD
8DFVARSP316	80	180	250	61,70 €
10DFVARSP316	100	200	250	66,29 €
120DFVARSP316	120	220	250	83,13 €
130DFVARSP316	130	230	250	78,19 €
150DFVARSP316	150	250	250	87,98 €
180DFVARSP316	180	280	250	88,67 €
200DFVARSP316	200	300	250	107,20 €
250DFVARSP316	250	350	250	145,11 €
300DFVARSP316	300	400	250	189,90 €
350DFVARSP316	350	450	250	282,04 €
400DFVARSP316	400	500	250	379,11 €
450DFVARSP316	450	550	250	345,65 €
500DFVARSP316	500	600	250	351,88 €
550DFVARSP316	550	650	250	429,50 €
600DFVARSP316	600	700	250	481,79 €

Terminal cono libre (Acero Inox 316)



CÓDIGO	Ø	Ø1	A	€/UD
8FCONICOSP316	80	130	135	30,97 €
10FCONICOSP316	100	150	135	33,03 €
120FCONICOSP316	120	175	135	36,23 €
130FCONICOSP316	130	180	135	35,31 €
150FCONICOSP316	150	200	135	38,15 €
180FCONICOSP316	180	230	135	41,42 €
200FCONICOSP316	200	250	135	52,24 €
250FCONICOSP316	250	300	135	62,45 €
300FCONICOSP316	300	350	135	75,38 €
350FCONICOSP316	350	400	135	84,34 €
400FCONICOSP316	400	450	135	95,68 €
450FCONICOSP316	450	500	135	100,30 €
500FCONICOSP316	500	550	135	117,49 €
550FCONICOSP316	550	600	135	148,01 €
600FCONICOSP316	600	650	135	186,40 €

Deflector vertical (Acero Inox 316)



CÓDIGO	Ø	Ø1	€/UD
8DFVSP316	80	200	41,91 €
10DFVSP316	100	200	45,05 €
120DFVSP316	120	250	42,60 €
130DFVSP316	130	250	56,86 €
150DFVSP316	150	300	61,92 €
180DFVSP316	180	400	69,47 €
200DFVSP316	200	400	81,05 €
250DFVSP316	250	500	102,38 €
300DFVSP316	300	500	134,42 €
350DFVSP316	350	600	139,80 €
400DFVSP316	400	600	155,62 €
450DFVSP316	450	700	155,04 €
500DFVSP316	500	700	160,36 €

AMPLIACIONES Y REDUCCIONES

CÓDIGO	€/UD
100120AMPSP316	38,49 €
100130AMPSP316	40,82 €
100150AMPSP316	43,15 €
100180AMPSP316	47,82 €
100200AMPSP316	53,65 €
100250AMPSP316	62,98 €
100300AMPSP316	69,98 €
100350AMPSP316	81,64 €
100400AMPSP316	93,30 €
100450AMPSP316	104,97 €
100500AMPSP316	116,63 €
10080REDS316	34,99 €
110100REDS316	38,49 €
110120AMPSP316	39,65 €
110130AMPSP316	41,99 €
110150AMPSP316	44,32 €
110180AMPSP316	48,98 €
110200AMPSP316	54,82 €
110250AMPSP316	64,15 €
110300AMPSP316	69,98 €
110350AMPSP316	81,64 €
110400AMPSP316	93,30 €
110450AMPSP316	104,97 €
110500AMPSP316	116,63 €
11080REDS316	37,32 €
120130AMPSP316	41,99 €
120150AMPSP316	44,32 €
120180AMPSP316	48,98 €
120200AMPSP316	53,65 €
120250AMPSP316	64,15 €
120300AMPSP316	69,98 €
120350AMPSP316	81,64 €
120400AMPSP316	93,30 €
120450AMPSP316	104,97 €
120500AMPSP316	116,63 €
12080REDS316	38,49 €
130100REDS316	40,82 €
130120REDS316	41,99 €
130150AMPSP316	44,32 €
130180AMPSP316	48,98 €
130200AMPSP316	53,65 €
130250AMPSP316	64,15 €
130300AMPSP316	69,98 €
130350AMPSP316	81,64 €
130400AMPSP316	93,30 €

CÓDIGO	€/UD
130450AMPSP316	104,97 €
130500AMPSP316	116,63 €
13080REDS316	40,82 €
140120REDS316	43,15 €
140130REDS316	43,74 €
140150AMPSP316	44,32 €
140180AMPSP316	50,15 €
140200AMPSP316	54,82 €
140250AMPSP316	64,15 €
140300AMPSP316	69,98 €
140350AMPSP316	81,64 €
140400AMPSP316	93,30 €
140450AMPSP316	104,97 €
140500AMPSP316	116,63 €
14080REDS316	41,99 €
150100REDS316	43,15 €
150120REDS316	43,74 €
150130REDS316	44,32 €
150180AMPSP316	48,98 €
150200AMPSP316	53,65 €
150250AMPSP316	64,15 €
150300AMPSP316	69,98 €
150350AMPSP316	81,64 €
150400AMPSP316	93,30 €
150450AMPSP316	104,97 €
150500AMPSP316	116,63 €
15080REDS316	40,82 €
160100REDS316	43,15 €
160110REDS316	45,49 €
160120REDS316	46,65 €
160130REDS316	47,82 €
160140REDS316	48,98 €
160150REDS316	50,15 €
160180AMPSP316	51,32 €
160200AMPSP316	53,65 €
160250AMPSP316	64,15 €
160300AMPSP316	69,98 €
160350AMPSP316	81,64 €
160400AMPSP316	93,30 €
160450AMPSP316	104,97 €
160500AMPSP316	116,63 €
16080REDS316	43,15 €
180100REDS316	46,65 €
180110REDS316	47,24 €
180120REDS316	47,82 €

CÓDIGO	€/UD
180130REDS316	48,40 €
180140REDS316	48,98 €
180150REDS316	49,57 €
180160REDS316	50,15 €
180200AMPSP316	53,65 €
180250AMPSP316	64,15 €
180300AMPSP316	69,98 €
180350AMPSP316	81,64 €
180400AMPSP316	93,30 €
180450AMPSP316	104,97 €
180500AMPSP316	116,63 €
18080REDS316	45,49 €
200100REDS316	50,15 €
200110REDS316	51,32 €
200120REDS316	51,90 €
200130REDS316	52,48 €
200140REDS316	53,07 €
200150REDS316	53,65 €
200160REDS316	54,23 €
200180REDS316	54,82 €
200250AMPSP316	64,15 €
200300AMPSP316	69,98 €
200350AMPSP316	81,64 €
200400AMPSP316	93,30 €
200450AMPSP316	104,97 €
200500AMPSP316	116,63 €
20080REDS316	50,15 €
250100REDS316	55,98 €
250110REDS316	58,32 €
250120REDS316	59,48 €
250130REDS316	60,65 €
250140REDS316	61,81 €
250150REDS316	62,98 €
250160REDS316	64,15 €
250180REDS316	65,31 €
250200REDS316	66,48 €
250300AMPSP316	69,98 €
250350AMPSP316	81,64 €
250400AMPSP316	93,30 €
250450AMPSP316	104,97 €
250500AMPSP316	116,63 €
25080REDS316	55,98 €
300100REDS316	60,65 €
300110REDS316	62,98 €
300120REDS316	64,15 €

CÓDIGO	€/UD
300130REDS316	66,48 €
300140REDS316	67,65 €
300150REDS316	68,81 €
300160REDS316	69,98 €
300180REDS316	71,14 €
300200REDS316	72,31 €
300250REDS316	73,48 €
300350AMPSP316	81,64 €
300400AMPSP316	93,30 €
300450AMPSP316	104,97 €
300500AMPSP316	116,63 €
30080REDS316	61,81 €
350100REDS316	69,98 €
350110REDS316	72,31 €
350120REDS316	73,48 €
350130REDS316	74,64 €
350140REDS316	75,81 €
350150REDS316	76,98 €
350160REDS316	77,56 €
350180REDS316	78,14 €
350200REDS316	78,73 €
350250REDS316	80,47 €
350300REDS316	81,64 €
350400AMPSP316	93,30 €
350450AMPSP316	104,97 €
350500AMPSP316	116,63 €
35080REDS316	71,14 €
400100REDS316	81,64 €
400110REDS316	82,81 €
400120REDS316	83,97 €
400130REDS316	85,14 €
400140REDS316	86,31 €
400150REDS316	87,47 €
400160REDS316	88,64 €
400180REDS316	89,81 €
400200REDS316	90,97 €
400250REDS316	92,14 €
400300REDS316	93,30 €
400350REDS316	94,47 €
400450AMPSP316	104,97 €
400500AMPSP316	116,63 €
40080REDS316	79,31 €
450100REDS316	87,47 €
450110REDS316	88,64 €
450120REDS316	89,81 €

CÓDIGO	€/UD
450130REDS316	90,97 €
450140REDS316	92,14 €
450150REDS316	93,30 €
450160REDS316	94,47 €
450180REDS316	95,64 €
450200REDS316	96,80 €
450250REDS316	97,97 €
450300REDS316	99,14 €
450350REDS316	100,30 €
450400REDS316	101,47 €
500100REDS316	102,63 €
500130REDS316	104,97 €
500140REDS316	106,13 €
500150REDS316	107,30 €
500160REDS316	108,47 €
500180REDS316	110,80 €
500200REDS316	111,96 €
500250REDS316	113,13 €
500300REDS316	114,30 €
500350REDS316	115,46 €
500400REDS316	116,63 €
500450REDS316	117,80 €
60100AMPSP316	36,16 €
80100AMPSP316	37,32 €
80110AMPSP316	38,49 €
80120AMPSP316	39,65 €
80130AMPSP316	40,82 €
80140AMPSP316	41,99 €
80150AMPSP316	43,15 €
80160AMPSP316	44,32 €
80180AMPSP316	48,98 €
80200AMPSP316	53,65 €
80250AMPSP316	64,15 €
80300AMPSP316	72,31 €
80350AMPSP316	81,64 €
80400AMPSP316	93,30 €
80450AMPSP316	104,97 €
80500AMPSP316	122,46 €

AMPLIACIONES

80 MACHO	80100AMPSP316	80110AMPSP316	80120AMPSP316	80130AMPSP316	80140AMPSP316	80150AMPSP316	80160AMPSP316	80180AMPSP316	80200AMPSP316	80250AMPSP316	80300AMPSP316	80350AMPSP316	80400AMPSP316	80450AMPSP316	80500AMPSP316
100 MACHO	10080REDSF316	100100REDSF316	100120AMPSP316	100130AMPSP316	100140AMPSP316	100150AMPSP316	100160AMPSP316	100180AMPSP316	100200AMPSP316	100250AMPSP316	100300AMPSP316	100350AMPSP316	100400AMPSP316	100450AMPSP316	100500AMPSP316
110 MACHO	11080REDSF316	110100REDSF316	110120AMPSP316	110130AMPSP316	110140AMPSP316	110150AMPSP316	110160AMPSP316	110180AMPSP316	110200AMPSP316	110250AMPSP316	110300AMPSP316	110350AMPSP316	110400AMPSP316	110450AMPSP316	110500AMPSP316
120 MACHO	12080REDSF316	120100REDSF316	120120AMPSP316	120130AMPSP316	120140AMPSP316	120150AMPSP316	120160AMPSP316	120180AMPSP316	120200AMPSP316	120250AMPSP316	120300AMPSP316	120350AMPSP316	120400AMPSP316	120450AMPSP316	120500AMPSP316
130 MACHO	13080REDSF316	130100REDSF316	130120REDSF316	130130AMPSP316	130140AMPSP316	130150AMPSP316	130160AMPSP316	130180AMPSP316	130200AMPSP316	130250AMPSP316	130300AMPSP316	130350AMPSP316	130400AMPSP316	130450AMPSP316	130500AMPSP316
140 MACHO	14080REDSF316	140100REDSF316	140120REDSF316	140130REDSF316	140140REDSF316	140150REDSF316	140160REDSF316	140180REDSF316	140200REDSF316	140250AMPSP316	140300REDSF316	140350REDSF316	140400REDSF316	140450REDSF316	140500REDSF316
150 MACHO	15080REDSF316	150100REDSF316	150120REDSF316	150130REDSF316	150140REDSF316	150150REDSF316	150160REDSF316	150180AMPSP316	150200AMPSP316	150250AMPSP316	150300AMPSP316	150350AMPSP316	150400AMPSP316	150450AMPSP316	150500AMPSP316
160 MACHO	16080REDSF316	160100REDSF316	160120REDSF316	160130REDSF316	160140REDSF316	160150REDSF316	160160REDSF316	160180REDSF316	160200REDSF316	160250REDSF316	160300REDSF316	160350REDSF316	160400REDSF316	160450REDSF316	160500REDSF316
180 MACHO	18080REDSF316	180100REDSF316	180120REDSF316	180130REDSF316	180140REDSF316	180150REDSF316	180160REDSF316	180180AMPSP316	180200AMPSP316	180250AMPSP316	180300AMPSP316	180350AMPSP316	180400AMPSP316	180450AMPSP316	180500AMPSP316
200 MACHO	20080REDSF316	200100REDSF316	200120REDSF316	200130REDSF316	200140REDSF316	200150REDSF316	200160REDSF316	200180REDSF316	200200REDSF316	200250AMPSP316	200300AMPSP316	200350AMPSP316	200400AMPSP316	200450AMPSP316	200500AMPSP316
250 MACHO	25080REDSF316	250100REDSF316	250120REDSF316	250130REDSF316	250140REDSF316	250150REDSF316	250160REDSF316	250180REDSF316	250200REDSF316	250250REDSF316	250300AMPSP316	250350AMPSP316	250400AMPSP316	250450AMPSP316	250500AMPSP316
300 MACHO	30080REDSF316	300100REDSF316	300120REDSF316	300130REDSF316	300140REDSF316	300150REDSF316	300160REDSF316	300180REDSF316	300200REDSF316	300250REDSF316	300300AMPSP316	300350AMPSP316	300400AMPSP316	300450AMPSP316	300500AMPSP316
350 MACHO	35080REDSF316	350100REDSF316	350120REDSF316	350130REDSF316	350140REDSF316	350150REDSF316	350160REDSF316	350180REDSF316	350200REDSF316	350250REDSF316	350300REDSF316	350350REDSF316	350400AMPSP316	350450AMPSP316	350500AMPSP316
400 MACHO	40080REDSF316	400100REDSF316	400120REDSF316	400130REDSF316	400140REDSF316	400150REDSF316	400160REDSF316	400180REDSF316	400200REDSF316	400250REDSF316	400300REDSF316	400350REDSF316	400400AMPSP316	400450AMPSP316	400500AMPSP316
450 MACHO	450100REDSF316	450100REDSF316	450120REDSF316	450130REDSF316	450140REDSF316	450150REDSF316	450160REDSF316	450180REDSF316	450200REDSF316	450250REDSF316	450300REDSF316	450350REDSF316	450400REDSF316	450450REDSF316	450500REDSF316
500 MACHO	500100REDSF316	500100REDSF316	500120REDSF316	500130REDSF316	500140REDSF316	500150REDSF316	500160REDSF316	500180REDSF316	500200REDSF316	500250REDSF316	500300REDSF316	500350REDSF316	500400REDSF316	500450REDSF316	500500REDSF316

REDUCCIONES

ChimenoX[®]

Coaxial

Coaxial

Conductos COAXIALES para evacuación de humos de combustión, en estufas y calderas de pellet en instalaciones individuales en INTERIOR.

Características:

- Material: Acero inox 316 interior / 304 exterior.
- Combustible: Pellets / Biomasa.
- Temperatura máxima: 200°C.
- Color: Negro mate.
- Unión entre piezas: Machihembrado.
- Junta de estanqueidad: Silicona de alta temperatura.
- Designación de producto:
 - T200-P1-D-Vm-L50050-O(40)M
- Diámetros disponibles:
 - $\varnothing 80/\varnothing 130$
 - $\varnothing 100/\varnothing 150$
 - $\varnothing 130/\varnothing 200$



Los dibujos de las piezas son orientativos, FIG S.L. se reserva el derecho de cambiar las características de los productos sin previo aviso.
Las dimensiones de las piezas son aproximadas, FIG S.L. no se hace responsable de problemas en la instalación de las mismas.



COMPLEMENTOS



TERMINALES



RECOGE CONDENSADOS



CODOS



TUBOS

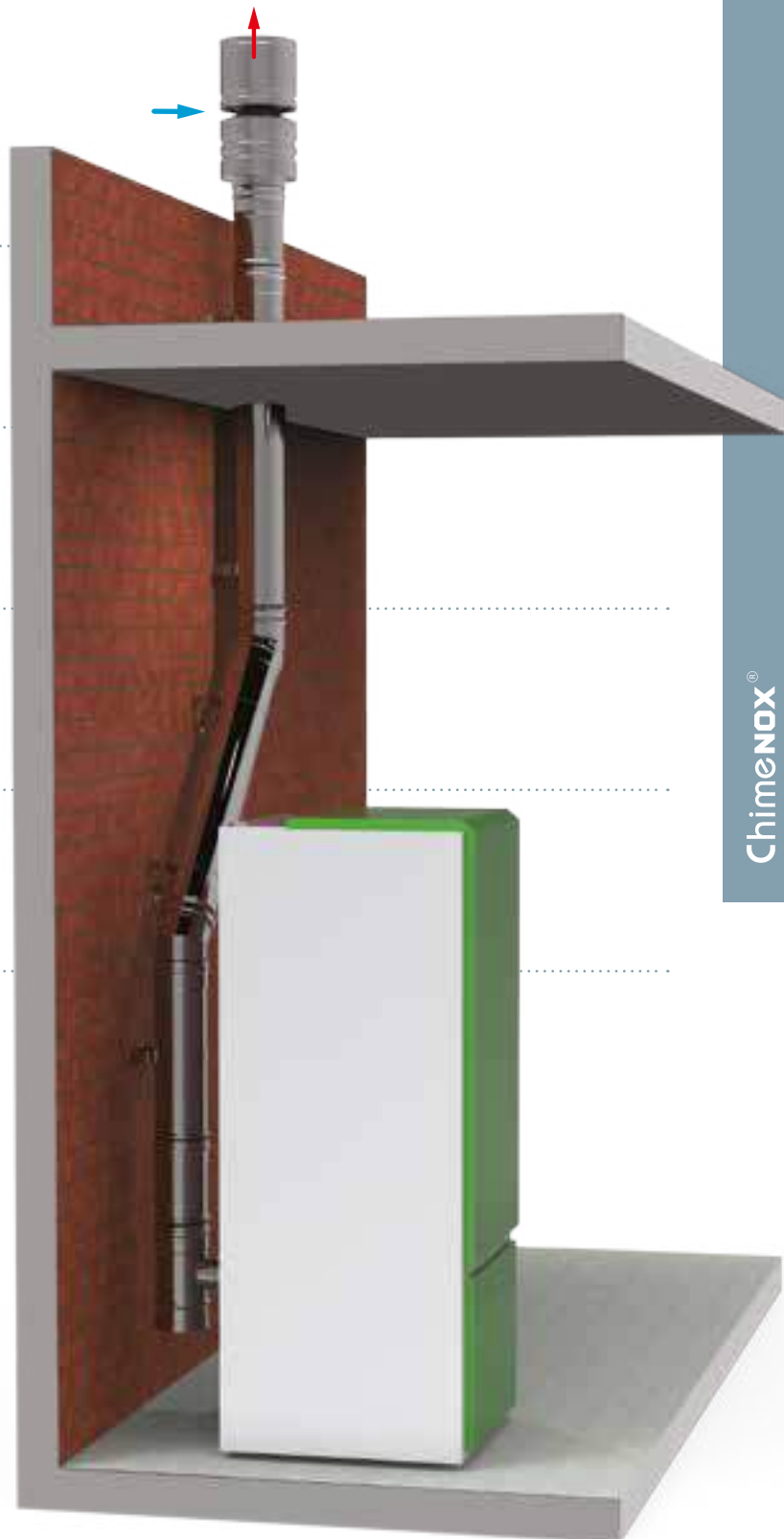

TUBOS

Tubo coaxial Macho - Hembra (Inox 316 interior / 304 exterior)



Acabado

CÓDIGO	Ø	LONGITUD	€/UD
8130-250MH316	Ø80 / Ø130	250	20,27 €
10150-250MH316	Ø100 / Ø150	250	74,32 €
130200-250MH316	Ø130 / Ø200	250	128,38 €

Tubo coaxial Macho - Hembra (Inox 316 interior / 304 exterior)



Acabado

CÓDIGO	Ø	LONGITUD	€/UD
8130-500MH316	Ø80 / Ø130	500	24,77 €
10150-500MH316	Ø100 / Ø150	500	78,83 €
130200-500MH316	Ø130 / Ø200	500	132,88 €

Tubo coaxial Macho - Hembra (Inox 316 interior / 304 exterior)



Acabado

CÓDIGO	Ø	LONGITUD	€/UD
8130-1000MH316	Ø80 / Ø130	1000	29,28 €
10150-1000MH316	Ø100 / Ø150	1000	117,23 €
130200-1000MH316	Ø130 / Ø200	1000	137,39 €

TUBOS TELESCÓPICOS

Tubo telescópico coaxial Macho - Hembra (Inox 316 int. / 304 ext.)



Acabado

CÓDIGO	Ø	LONGITUD	€/UD
8130TLMH316	Ø80 / Ø130	340 - 550	33,78 €
10150TLMH316	Ø100 / Ø150	340 - 550	166,83 €
130200TLMH316	Ø130 / Ø200	340 - 550	141,89 €

CODOS

Codo 45° coaxial Macho - Hembra (Inox 316 interior / 304 exterior)



Acabado

CÓDIGO	Ø	€/UD
8130-45MH316	Ø80 / Ø130	42,79 €
10150-45MH316	Ø100 / Ø150	83,44 €
130200-45MH316	Ø130 / Ø200	150,90 €

Codo 90° coaxial Macho - Hembra (Inox 316 interior / 304 exterior)

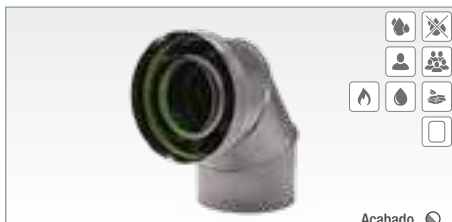

Acabado

CÓDIGO	Ø	€/UD
8130-90MH316	Ø80 / Ø130	38,29 €
10150-90MH316	Ø100 / Ø150	128,68 €
130200-90MH316	Ø130 / Ø200	146,40 €

RECIGE CONDENSADOS E INSPECCIONES

Te coaxial Macho - Hembra (Inox 316 interior / 304 exterior)



Acabado

CÓDIGO	Ø	€/UD
8130TE316	Ø80 / Ø130	47,30 €
10150TE316	Ø100 / Ø150	206,62 €
130200TE316	Ø130 / Ø200	155,41 €

Tape coaxial Macho - Hembra (Inox 316 interior / 304 exterior)

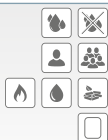

Acabado

CÓDIGO	Ø	€/UD
8130TAPE316	Ø80 / Ø130	51,80 €
10150TAPE316	Ø100 / Ø150	114,51 €
130200TAPE316	Ø130 / Ø200	159,91 €

Inspección coaxial Macho - Hembra (Inox 316 interior / 304 exterior)

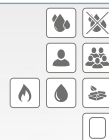

Acabado

CÓDIGO	Ø	€/UD
8130INSP316	Ø80 / Ø130	56,31 €
10150INSP316	Ø100 / Ø150	110,36 €
130200INSP316	Ø130 / Ø200	164,41 €

COMPLEMENTOS

Abrazadera (Inox 316)



Acabado

CÓDIGO	Ø	€/UD
130ABR316	Ø130	69,82 €
150ABR316	Ø150	123,87 €
200ABR316	Ø200	177,93 €

TERMINALES

Deflector horizontal coaxial Inox 316 interior / 304 exterior



Acabado

CÓDIGO	Ø	€/UD
8130DFH316	Ø80 / Ø130	65,32 €
10150DFH316	Ø100 / Ø150	119,37 €
130200DFH316	Ø130 / Ø200	173,42 €

Deflector antirrevoque coaxial (Inox 316 interior / 304 exterior)



Acabado

CÓDIGO	Ø	€/UD
8130DFAR316	Ø80 / Ø130	60,81 €
10150DFAR316	Ø100 / Ø150	114,86 €
130200DFAR316	Ø130 / Ø200	168,92 €

ChimeNOX[®]

Flexible

Flexible

Conductos FLEXIBLES con interior liso para evacuación de humos de combustión de hogares y calderas de gas o gasoil en instalaciones individuales o colectivas en INTERIOR.

Características:

- Material: Acero inoxidable AISI 316.
- Combustible: Leña, biomasa, gas o gasoil.
- Temperatura máxima:
 - 200°C con junta.
 - 600°C sin junta.
- Unión entre piezas: Machihembrada.
- Color: Acero inox.
- Junta de estanqueidad: Silicona.
- Designación de producto:
 - Sistema con junta:
 - EN1856-2-T200-P1-W-Vm-L50010-O
 - Sistema sin junta:
 - EN1856-2-T450-N1-W-Vm-L50010-G
- Diámetros disponibles:
 - ø100 - ø130 - ø150 - ø180 - ø200 - ø250



TUBOS

Tubo interior liso con Dispenser (Acero Inox 316)



Acabado

CÓDIGO	Ø	LONGITUD	€/UD
TUBOFLEXNOX80	80	30 m.	823,90 €
TUBOFLEXNOX100	100	30 m.	951,48 €
TUBOFLEXNOX130	130	30 m.	1.303,26 €
TUBOFLEXNOX150	150	30 m.	1.551,50 €
TUBOFLEXNOX180	180	25 m.	1.551,50 €
TUBOFLEXNOX200	200	25 m.	1.737,68 €
TUBOFLEXNOX250	250	20 m.	1.880,57 €

UNIONES

Unión Flex a rígido hembra Anticondensación (Acero Inox 316)



Acabado

CÓDIGO	Ø	Ø1	A	€/UD
ADRFLEXNOX80	80	80	160	19,10 €
ADRFLEXNOX100	100	100	160	19,94 €
ADRFLEXNOX130	130	130	160	23,25 €
ADRFLEXNOX150	150	150	160	24,90 €
ADRFLEXNOX180	180	180	160	29,06 €
ADRFLEXNOX200	200	200	160	30,73 €
ADRFLEXNOX250	250	250	160	40,68 €

Unión rígido macho a Flex (Acero Inox 316)



Acabado

CÓDIGO	Ø	Ø1	A	€/UD
ADRMFLEXNOX80	80	80	125	19,10 €
ADRMFLEXNOX100	100	100	125	19,94 €
ADRMFLEXNOX130	130	130	125	23,25 €
ADRMFLEXNOX150	150	150	125	24,90 €
ADRMFLEXNOX180	180	180	125	29,06 €
ADRMFLEXNOX200	200	200	125	30,73 €
ADRMFLEXNOX250	250	250	125	40,68 €

Unión Flex - Flex Anticondensación (Acero Inox 316)



Acabado

CÓDIGO	Ø	A	€/UD
ADFLEXFLEXNOX80	80	194	19,10 €
ADFLEXFLEXNOX100	100	194	19,94 €
ADFLEXFLEXNOX130	130	194	23,25 €
ADFLEXFLEXNOX150	150	194	24,90 €
ADFLEXFLEXNOX180	180	194	29,06 €
ADFLEXFLEXNOX200	200	194	30,73 €
ADFLEXFLEXNOX250	250	194	40,68 €



Los dibujos de las piezas son orientativos, FIG S.L. se reserva el derecho de cambiar las características de los productos sin previo aviso.
Las dimensiones de las piezas son aproximadas, FIG S.L. no se hace responsable de problemas en la instalación de las mismas.

ChimeNOX[®]

CONDUCTOS Y COMPONENTES PARA APARATOS TRADICIONALES EN
INSTALACIONES INDIVIDUALES Y COLECTIVAS

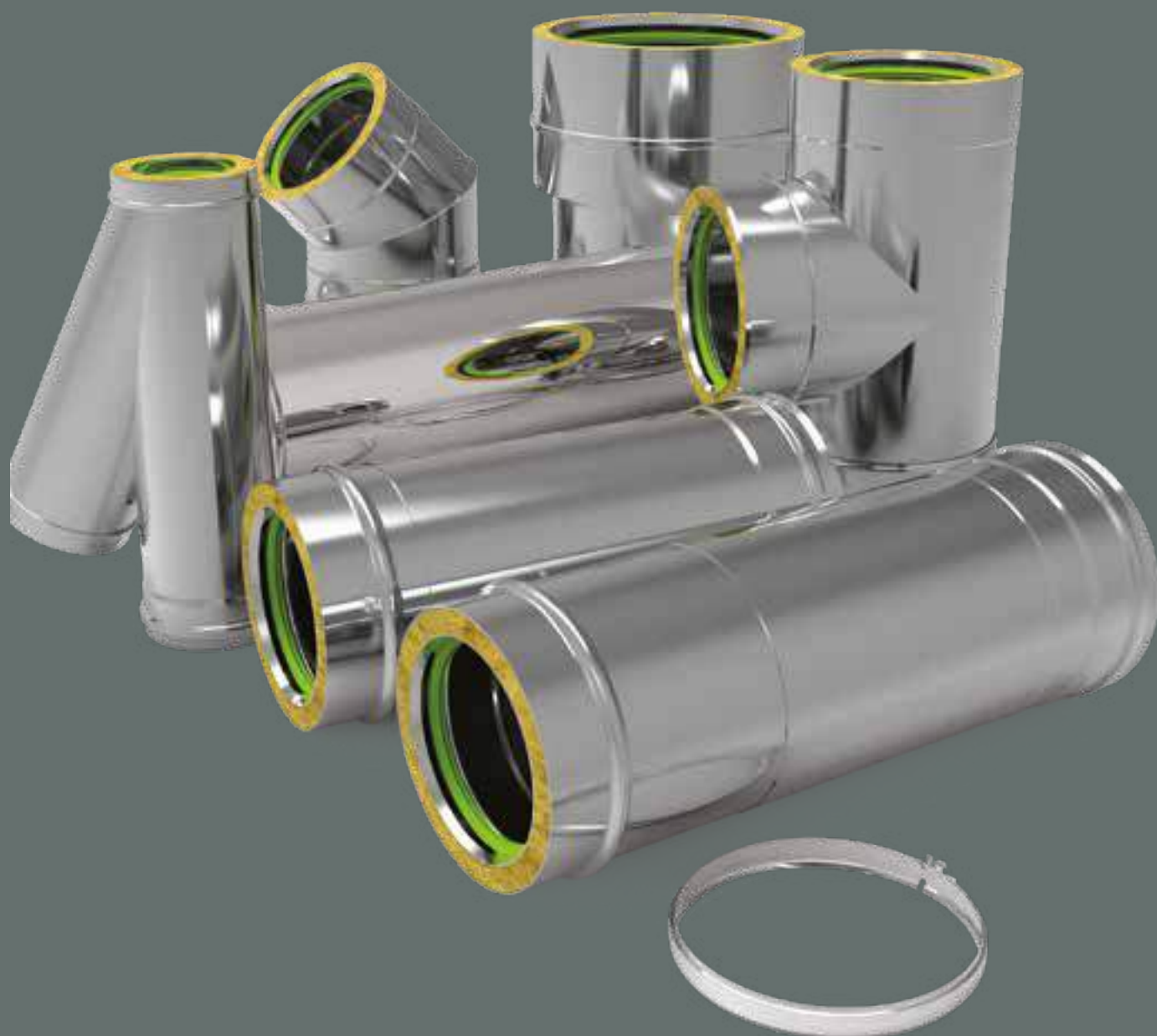

DOBLE PARED (aislado Inox 316/304)

Conductos para evacuación de humos de combustión de hogares, calderas de condensación y biomasa en instalaciones individuales o colectivas en INTERIOR y EXTERIOR.

Características:

- Material interior: Acero inoxidable AISI 316.
- Material exterior: Acero inoxidable AISI 304.
- Material aislante: Lana de roca 25 mm. espesor
- Espesor mínimo: 0,5 mm.
- Combustible Gas, gasoil, leña y biomasa.
- Temperatura máxima:
 - 200°C con junta.
 - 600°C sin junta.
- Unión entre piezas: Machihembrada.
- Color: Acero inox.
- Junta de estanqueidad: Silicona.
- Designación de producto:
 - Sistema con junta:
 - EN1856-1-T200-P1-W-V2-L50050-O(50)
 - Sistema sin junta:
 - EN1856-2-T600-N1-D-V2-L50050-G(70)
- Diámetros disponibles:
 - ø80 - ø100 - ø120 - ø130 - ø150 - ø180 - ø200 - ø250 - ø300 - ø350 - ø400 - ø450 - ø500 - ø550 - ø600

DOBLE PARED (aislado Inox 304/304)

Conductos para evacuación de humos de combustión de calderas de gas o gasoil NO condensación en instalaciones individuales o colectivas en INTERIOR y EXTERIOR.

Características:

- Material interior: Acero inoxidable AISI 304.
- Material exterior: Acero inoxidable AISI 304.
- Material aislante: Lana de roca 25 mm. espesor
- Espesor mínimo: 0,5 mm.
- Combustible: Gas o gasoil NO condensación.
- Temperatura máxima:
 - 200°C con junta.
 - 600°C sin junta.
- Unión entre piezas: Machihembrada.
- Color: Acero inox.
- Junta de estanqueidad: Silicona.
- Designación de producto:
 - Sistema con junta:
 - EN1856-1-T200-P1-W-Vm-L20040-O(50)
 - Sistema sin junta:
 - EN1856-1-T600-N1-D-Vm-L20040-G(70)
- Diámetros disponibles:
 - ø100 - ø130 - ø150 - ø180 - ø200 - ø250 - ø300 - ø350 - ø400 - ø450 - ø500 - ø550 - ø600

ChimeNOX®

Doble pared 316/304

DOBLE PARED (aislado Inox 316/304) _____

Conductos para evacuación de humos de combustión de hogares, calderas de condensación y biomasa en instalaciones individuales o colectivas en INTERIOR y EXTERIOR.

Características:

- Material interior: Acero inoxidable AISI 316.
- Material exterior: Acero inoxidable AISI 304.
- Material aislante: Lana de roca 25 mm. espesor
- Espesor mínimo: 0,5 mm.
- Combustible Gas, gasoil, leña y biomasa.
- Temperatura máxima:
 - 200°C con junta.
 - 600°C sin junta.
- Unión entre piezas: Machihembrada.
- Color: Acero inox.
- Junta de estanqueidad: Silicona.
- Designación de producto:
 - Sistema con junta:
 - EN1856-1-T200-P1-W-V2-L50050-O(50)
 - Sistema sin junta:
 - EN1856-2-T600-N1-D-V2-L50050-G(70)
- Diámetros disponibles:
 - ø80 - ø100 - ø120 - ø130 - ø150 - ø180 - ø200 - ø250 - ø300 - ø350 - ø400 - ø450 - ø500 - ø550 - ø600



Los dibujos de las piezas son orientativos, FIG S.L. se reserva el derecho de cambiar las características de los productos sin previo aviso.
Las dimensiones de las piezas son aproximadas, FIG S.L. no se hace responsable de problemas en la instalación de las mismas.



TERMINALES



COMPLEMENTOS



ADAPTADORES



RECOGE CONDENSADOS



TUBOS Y CODOS

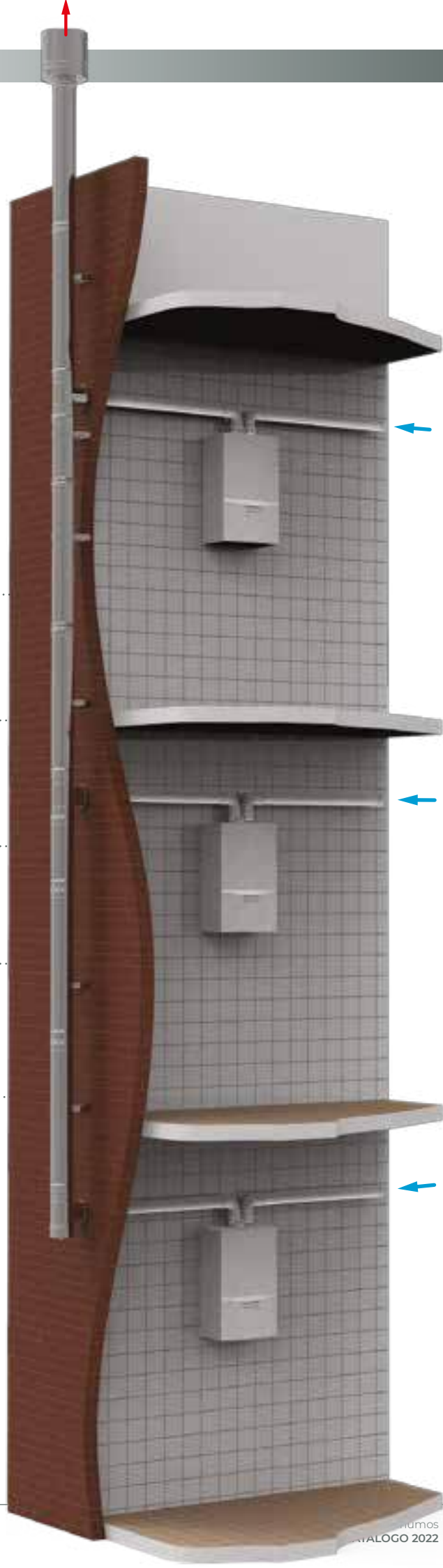

TUBOS

Tubo Macho - Hembra (Inox 316-Interior / Inox 304-Exterior)



CÓDIGO	Ø	Ø1	L	€/UD
8-250DP316	80	130	250	46,30 €
10-250DP316	100	150	250	51,23 €
130-250DP316	130	180	250	62,61 €
150-250DP316	150	200	250	68,61 €
180-250DP316	180	230	250	77,46 €
200-250DP316	200	250	250	92,23 €
250-250DP316	250	300	250	111,91 €
300-250DP316	300	350	250	130,70 €
350-250DP316	350	450	250	151,96 €
400-250DP316	400	500	250	196,54 €
450-250DP316	450	550	250	216,58 €
500-250DP316	500	600	250	251,35 €
550-250DP316	550	650	250	273,12 €
600-250DP316	600	750	250	306,41 €

Tubo Macho - Hembra (Inox 316-Interior / Inox 304-Exterior)



CÓDIGO	Ø	Ø1	L	€/UD
8-500DP316	80	130	500	53,76 €
10-500DP316	100	150	500	59,49 €
130-500DP316	130	180	500	72,41 €
150-500DP316	150	200	500	79,82 €
180-500DP316	180	230	500	88,94 €
200-500DP316	200	250	500	107,62 €
250-500DP316	250	300	500	128,75 €
300-500DP316	300	350	500	160,13 €
350-500DP316	350	450	500	171,79 €
400-500DP316	400	500	500	221,93 €
450-500DP316	450	550	500	243,68 €
500-500DP316	500	600	500	320,67 €
550-500DP316	550	650	500	452,99 €
600-500DP316	600	750	500	576,72 €

Tubo Macho - Hembra (Inox 316-Interior / Inox 304-Exterior)



CÓDIGO	Ø	Ø1	L	€/UD
8-1000DP316	80	130	1000	84,42 €
10-1000DP316	100	150	1000	91,60 €
130-1000DP316	130	180	1000	109,09 €
150-1000DP316	150	200	1000	120,73 €
180-1000DP316	180	230	1000	133,76 €
200-1000DP316	200	250	1000	163,66 €
250-1000DP316	250	300	1000	207,20 €
300-1000DP316	300	350	1000	247,24 €
350-1000DP316	350	450	1000	286,77 €
400-1000DP316	400	500	1000	362,18 €
450-1000DP316	450	550	1000	396,95 €
500-1000DP316	500	600	1000	436,80 €
550-1000DP316	550	650	1000	765,22 €
600-1000DP316	600	750	1000	930,29 €

TUBOS TELESCÓPICOS

Tubo telescópico (Inox 316-Interior / Inox 304-Exterior)



CÓDIGO	Ø	Ø1	L. MÁX	L. MIN	€/UD
80TLDP316	80	130	884	507	114,64 €
100TLDP316	100	150	884	507	127,16 €
130TLDP316	130	180	884	507	140,39 €
150TLDP316	150	200	884	507	154,81 €
180TLDP316	180	230	884	507	169,27 €
200TLDP316	200	250	884	507	204,03 €
250TLDP316	250	300	884	507	253,00 €
300TLDP316	300	350	884	507	291,99 €
350TLDP316	350	450	884	507	357,46 €
400TLDP316	400	500	884	507	448,92 €
450TLDP316	450	550	884	507	485,72 €
500TLDP316	500	600	884	507	522,33 €
550TLDP316	550	650	884	507	862,66 €
600TLDP316	600	700	884	507	1.034,41 €

Tubo telescópico corto (Inox 316-Interior / Inox 304-Exterior)



CÓDIGO	Ø	Ø1	L. MÁX	L. MIN	€/UD
80TLCORTODP316	80	130	384	257	90,79 €
100TLCORTODP316	100	150	384	257	100,84 €
130TLCORTODP316	130	180	384	257	112,40 €
150TLCORTODP316	150	200	384	257	122,60 €
180TLCORTODP316	180	230	384	257	135,64 €
200TLCORTODP316	200	250	384	257	162,00 €
250TLCORTODP316	250	300	384	257	195,27 €
300TLCORTODP316	300	350	384	257	230,10 €
350TLCORTODP316	350	450	384	257	271,54 €
400TLCORTODP316	400	500	384	257	275,53 €
450TLCORTODP316	450	550	384	257	308,87 €
500TLCORTODP316	500	600	384	257	332,86 €
550TLCORTODP316	550	650	384	257	407,51 €
600TLCORTODP316	600	700	384	257	438,12 €

CODOS

Codo 90° (Inox 316-Interior / Inox 304-Exterior)



CÓDIGO	Ø	Ø1	A	B	€/UD
8-90DP316	80	130	178	238	128,89 €
10-90DP316	100	150	175	250	137,90 €
130-90DP316	130	180	186	276	147,06 €
150-90DP316	150	200	200	300	162,47 €
180-90DP316	180	230	210	325	183,24 €
200-90DP316	200	250	215	340	212,62 €
250-90DP316	250	300	252	402	256,16 €
300-90DP316	300	350	275	450	303,01 €
350-90DP316	350	450	327	552	443,45 €
400-90DP316	400	500	355	605	438,56 €
450-90DP316	450	550	380	655	568,36 €
500-90DP316	500	600	446	746	729,65 €
550-90DP316	550	650	-	-	1.058,92 €
600-90DP316	600	700	-	-	1.151,98 €

Codo 45° (Inox 316-Interior / Inox 304-Exterior)



CÓDIGO	Ø	Ø1	A	B	€/UD
8-45DP316	80	130	72	119	66,77 €
10-45DP316	100	150	75	126	71,63 €
130-45DP316	130	180	79	141	78,04 €
150-45DP316	150	200	82	148	85,68 €
180-45DP316	180	230	87	159	95,95 €
200-45DP316	200	250	89	166	111,83 €
250-45DP316	250	300	97	184	134,35 €
300-45DP316	300	350	105	202	158,69 €
350-45DP316	350	450	118	237	231,65 €
400-45DP316	400	500	126	255	267,66 €
450-45DP316	450	550	133	272	335,27 €
500-45DP316	500	600	140	290	442,86 €
550-45DP316	550	650	147	308	631,60 €
600-45DP316	600	700	154	326	735,34 €

Codo 30° (Inox 316-Interior / Inox 304-Exterior)



CÓDIGO	Ø	Ø1	A	B	€/UD
8-30DP316	80	130	46	124	61,95 €
10-30DP316	100	150	48	127	67,69 €
130-30DP316	130	180	49	135	85,76 €
150-30DP316	150	200	51	140	91,34 €
180-30DP316	180	230	53	147	97,10 €
200-30DP316	200	250	54	152	105,13 €
250-30DP316	250	300	57	165	127,40 €
300-30DP316	300	350	60	177	151,14 €
350-30DP316	350	450	67	202	178,68 €
400-30DP316	400	500	70	215	228,19 €
450-30DP316	450	550	74	227	279,93 €
500-30DP316	500	600	77	240	346,39 €
550-30DP316	550	650	80	254	613,20 €
600-30DP316	600	700	84	269	713,92 €

TES

Te 90° sin tapón (Inox 316-Interior / Inox 304-Exterior)



CÓDIGO	Ø	Ø1	A	B	C	€/UD
8TE90DP316	80	130	440	242	140	109,86 €
10TE90DP316	100	150	440	242	150	117,57 €
130TE90DP316	130	180	440	242	165	125,93 €
150TE90DP316	150	200	440	242	175	145,01 €
180TE90DP316	180	230	440	242	190	194,47 €
200TE90DP316	200	250	440	242	200	220,82 €
250TE90DP316	250	300	440	242	225	267,02 €
300TE90DP316	300	350	440	270	250	311,65 €
350TE90DP316	350	450	440	320	300	516,17 €
400TE90DP316	400	500	440	345	325	566,03 €
450TE90DP316	450	550	440	370	350	699,01 €
500TE90DP316	500	600	440	390	375	890,32 €
550TE90DP316	550	650	440	410	400	1.860,55 €
600TE90DP316	600	700	440	430	425	2.006,16 €

Te 45° sin tapón (Inox 316-Interior / Inox 304-Exterior)



CÓDIGO	Ø	Ø1	A	B	€/UD
8TE45DP316	80	130	423	228	231,57 €
10TE45DP316	100	150	458	248	300,53 €
130TE45DP316	130	180	498	270	334,21 €
150TE45DP316	150	200	526	288	385,67 €
180TE45DP316	180	230	564	312	421,38 €
200TE45DP316	200	250	592	330	479,44 €
250TE45DP316	250	300	664	372	730,37 €
300TE45DP316	300	350	738	416	914,51 €
350TE45DP316	350	450	880	500	962,39 €
400TE45DP316	400	500	952	544	1.014,86 €
450TE45DP316	450	550	1022	586	1.184,70 €
500TE45DP316	500	600	1092	928	1.496,94 €
550TE45DP316	550	650	1162	-	1.638,31 €
600TE45DP316	600	700	1232	-	2.393,33 €

Tape con purga (Inox 316-Interior / Inox 304-Exterior)



CÓDIGO	Ø	Ø1	A	B	€/UD
8TAPECONDDP316	80	130	75	3/4"	51,37 €
10TAPECONDDP316	100	150	75	3/4"	55,19 €
130TAPECONDDP316	130	180	75	3/4"	61,09 €
150TAPECONDDP316	150	200	75	3/4"	61,38 €
180TAPECONDDP316	180	230	75	3/4"	63,51 €
200TAPECONDDP316	200	250	75	3/4"	70,83 €
250TAPECONDDP316	250	300	75	3/4"	83,71 €
300TAPECONDDP316	300	350	75	3/4"	96,56 €
350TAPECONDDP316	350	450	75	3/4"	146,86 €
400TAPECONDDP316	400	500	75	3/4"	159,52 €
450TAPECONDDP316	450	550	75	3/4"	225,08 €
500TAPECONDDP316	500	600	75	3/4"	245,39 €
550TAPECONDDP316	550	650	75	3/4"	363,05 €
600TAPECONDDP316	600	700	75	3/4"	432,16 €

COLECTORES, ADAPTADORES Y CORTATIROS

Colector vertical entronque Ø80 (Inox 316-Interior / Inox 304-Exterior)



CÓDIGO	Ø	Ø1	A	B	C	€/UD
8100COLVERDP316	100	150	275	110	80	152,55 €
8130COLVERDP316	130	180	275	115	80	176,07 €
8150COLVERDP316	150	200	275	125	80	196,53 €
8180COLVERDP316	180	230	275	140	80	210,84 €
8200COLVERDP316	200	250	275	150	80	224,66 €
8250COLVERDP316	250	300	275	175	80	278,60 €
8300COLVERDP316	300	350	275	200	80	323,04 €
8350COLVERDP316	350	450	275	250	80	373,21 €
8400COLVERDP316	400	500	275	275	80	407,95 €
8450COLVERDP316	450	550	275	300	80	504,63 €
8500COLVERDP316	500	600	275	325	80	627,27 €
8550COLVERDP316	550	650	275	350	80	1.817,03 €
8600COLVERDP316	600	700	275	375	80	1.992,76 €

Adaptador caldera simple / doble (Inox 316-Interior / Inox 304-Exterior)



CÓDIGO	Ø	Ø1	A	€/UD
8ADAPSPDP316	80	130	110	33,61 €
10ADAPSPDP316	100	150	110	38,19 €
130ADAPSPDP316	130	180	110	50,45 €
150ADAPSPDP316	150	200	110	54,61 €
180ADAPSPDP316	180	230	110	57,90 €
200ADAPSPDP316	200	250	110	63,42 €
250ADAPSPDP316	250	300	110	82,62 €
300ADAPSPDP316	300	350	110	109,56 €
350ADAPSPDP316	350	450	110	166,22 €
400ADAPSPDP316	400	500	110	210,51 €
450ADAPSPDP316	450	550	110	220,90 €
500ADAPSPDP316	500	600	110	253,26 €
550ADAPSPDP316	550	650	110	288,00 €
600ADAPSPDP316	600	750	110	342,32 €

Cortatiros (Inox 316-Interior / Inox 304-Exterior)



CÓDIGO	Ø	Ø1	L	€/UD
8CORTATDP316	80	130	275	consultar
10CORTATDP316	100	150	275	consultar
130CORTATDP316	130	180	275	consultar
150CORTATDP316	150	200	275	consultar
180CORTATDP316	180	230	275	consultar
200CORTATDP316	200	250	275	consultar
250CORTATDP316	250	300	275	consultar
300CORTATDP316	300	350	275	consultar

INSPECCIONES

Módulo toma muestra (Inox 316-Interior / Inox 304-Exterior)



CÓDIGO	Ø	Ø1	A	€/UD
8TMDP316	80	130	239	92,61 €
10TMDP316	100	150	239	99,24 €
130TMDP316	130	180	239	107,18 €
150TMDP316	150	200	239	114,80 €
180TMDP316	180	230	239	122,14 €
200TMDP316	200	250	239	132,71 €
250TMDP316	250	300	239	162,32 €
300TMDP316	300	350	239	176,28 €
350TMDP316	350	450	239	200,82 €
400TMDP316	400	500	239	224,18 €
450TMDP316	450	550	239	237,89 €
500TMDP316	500	600	239	271,71 €
550TMDP316	550	650	239	457,68 €
600TMDP316	600	700	239	522,77 €

Tramo inspección (Inox 316-Interior / Inox 304-Exterior)



CÓDIGO	Ø	Ø1	A	B	C	€/UD
8INSPDP316	80	130	275	98	80	177,77 €
10INSPDP316	100	150	275	108	100	190,56 €
130INSPDP316	130	180	275	123	130	212,66 €
150INSPDP316	150	200	275	133	150	247,10 €
180INSPDP316	180	230	275	148	180	264,14 €
200INSPDP316	200	250	275	158	200	278,50 €
250INSPDP316	250	300	275	183	250	361,66 €
300INSPDP316	300	350	275	208	300	389,75 €
350INSPDP316	350	450	275	258	350	471,86 €
400INSPDP316	400	500	275	283	400	542,38 €
450INSPDP316	450	550	275	308	450	599,99 €
500INSPDP316	500	600	275	333	500	741,42 €
550INSPDP316	550	650	275	358	550	1.776,44 €
600INSPDP316	600	700	275	383	600	1.876,79 €

COMPLEMENTOS

Soporte chimenea alta carga (Inox 316-Interior / Inox 304-Exterior)



CÓDIGO	Ø	Ø1	A	□B	€/UD
8SOPCHIDP316	80	130	140	180	92,82 €
10SOPCHIDP316	100	150	140	200	99,62 €
130SOPCHIDP316	130	180	140	230	114,28 €
150SOPCHIDP316	150	200	140	250	125,81 €
180SOPCHIDP316	180	230	140	280	147,77 €
200SOPCHIDP316	200	250	140	300	182,77 €
250SOPCHIDP316	250	300	140	350	204,22 €
300SOPCHIDP316	300	350	140	400	227,02 €
350SOPCHIDP316	350	450	140	450	268,19 €
400SOPCHIDP316	400	500	140	500	331,40 €
450SOPCHIDP316	450	550	140	550	396,78 €
500SOPCHIDP316	500	600	140	600	454,97 €
550SOPCHIDP316	550	650	140	650	938,66 €
600SOPCHIDP316	600	700	140	700	1.114,39 €

Base (Inox 316/304)



CÓDIGO	Ø	Ø1	A	□B	€/UD
8BASEACDP316	80	130	100	230	92,82 €
10BASEACDP316	100	150	100	250	99,62 €
130BASEACDP316	130	180	100	280	114,28 €
150BASEACDP316	150	200	100	300	125,81 €
180BASEACDP316	180	230	100	280	147,77 €
200BASEACDP316	200	250	100	350	179,38 €
250BASEACDP316	250	300	100	400	204,21 €
300BASEACDP316	300	350	100	450	219,67 €
350BASEACDP316	350	450	100	550	259,57 €
400BASEACDP316	400	500	100	600	292,14 €
450BASEACDP316	450	550	100	650	314,77 €
500BASEACDP316	500	600	100	700	322,05 €
550BASEACDP316	550	650	100	750	1.015,20 €
600BASEACDP316	600	700	100	800	1.202,39 €

Escuadras soporte y base alta carga (dos unidades) (Inox 304)



CÓDIGO	Ø	€/UD
8KITESCUDRAS	80	34,22 €
10KITESCUDRAS	100	34,70 €
130KITESCUDRAS	130	40,70 €
150KITESCUDRAS	150	43,32 €
180KITESCUDRAS	180	47,76 €
200KITESCUDRAS	200	56,32 €
250KITESCUDRAS	250	83,55 €
300KITESCUDRAS	300	99,39 €
350KITESCUDRAS	350	151,85 €
400KITESCUDRAS	400	183,65 €
450KITESCUDRAS	450	206,68 €
500KITESCUDRAS	500	245,56 €
550KITESCUDRAS	550	255,94 €
600KITESCUDRAS	600	316,98 €

Vierteaguas (Inox 304)



CÓDIGO	Ø	Ø1	A	€/UD
8VIERTEAGUADP	130	230	105	28,68 €
10VIERTEAGUADP	150	250	105	28,68 €
130VIERTEAGUADP	180	280	105	28,68 €
150VIERTEAGUADP	200	300	105	31,39 €
180VIERTEAGUADP	230	330	105	34,30 €
200VIERTEAGUADP	250	350	105	34,30 €
250VIERTEAGUADP	300	400	105	35,87 €
300VIERTEAGUADP	350	450	105	37,44 €
350VIERTEAGUADP	450	550	105	41,81 €
400VIERTEAGUADP	500	600	105	48,98 €
450VIERTEAGUADP	550	650	105	53,37 €
500VIERTEAGUADP	600	700	105	63,97 €
550VIERTEAGUADP	650	750	105	180,24 €
600VIERTEAGUADP	700	800	105	192,50 €

Teja de 5° a 25° (Inox 304)



CÓDIGO	Ø	Ø1	A	□B	€/UD
8TEJA30DP304	130	160	175	625	123,68 €
10TEJA30DP304	150	180	175	625	131,99 €
130TEJA30DP304	180	210	175	625	131,99 €
150TEJA30DP304	200	230	175	750	163,27 €
180TEJA30DP304	230	260	175	750	185,58 €
200TEJA30DP304	250	280	190	750	185,58 €
250TEJA30DP304	300	330	190	850	215,23 €
300TEJA30DP304	350	380	200	850	243,31 €
350TEJA30DP304	450	480	200	950	276,27 €
400TEJA30DP304	500	530	200	950	321,64 €
450TEJA30DP304	550	580	250	1050	402,04 €
500TEJA30DP304	600	630	250	1050	502,56 €
550TEJA30DP304	650	680	250	1150	644,48 €
600TEJA30DP304	700	730	250	1150	732,29 €

Teja plana (Inox 304)

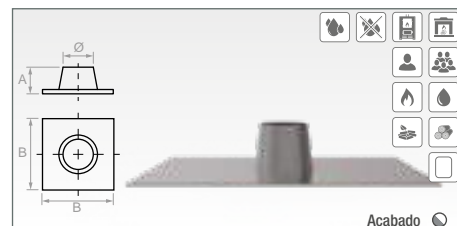

CÓDIGO	Ø	Ø1	A	□B	€/UD
8TEJADP304	130	250	170	625	111,31 €
10TEJADP304	150	270	170	625	118,79 €
130TEJADP304	180	300	170	625	118,79 €
150TEJADP304	200	320	170	750	130,62 €
180TEJADP304	230	350	170	750	167,02 €
200TEJADP304	250	370	170	750	167,02 €
250TEJADP304	300	420	170	850	179,36 €
300TEJADP304	350	470	170	850	218,98 €
350TEJADP304	450	570	170	950	248,64 €
400TEJADP304	500	620	170	950	289,48 €
450TEJADP304	550	670	170	1050	361,84 €
500TEJADP304	600	720	170	1050	452,30 €
550TEJADP304	650	770	170	1150	641,93 €
600TEJADP304	700	820	170	1150	738,61 €

Soporte Mural (Inox 304)

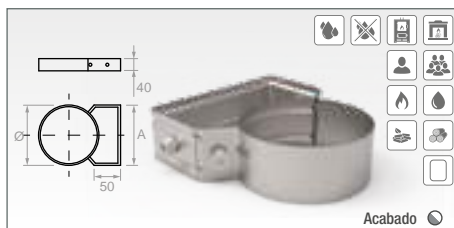

CÓDIGO	Ø	A	€/UD
8SOPMURDP304	130	141	18,96 €
10SOPMURDP304	150	156	19,53 €
130SOPMURDP304	180	176	21,20 €
150SOPMURDP304	200	193	23,07 €
180SOPMURDP304	230	215	24,78 €
200SOPMURDP304	250	228	25,95 €
250SOPMURDP304	300	264	30,81 €
300SOPMURDP304	350	300	36,06 €
350SOPMURDP304	450	371	43,52 €
400SOPMURDP304	500	406	47,71 €
450SOPMURDP304	550	442	91,83 €
500SOPMURDP304	600	476	99,58 €
550SOPMURDP304	650	510	272,85 €
600SOPMURDP304	700	545	277,77 €

Abrazadera vientos (Inox 304)



CÓDIGO	Ø	LONGITUD	€/UD
8ABRVIENTDP304	130	170	18,25 €
10ABRVIENTDP304	150	190	19,51 €
130ABRVIENTDP304	180	220	19,93 €
150ABRVIENTDP304	200	240	20,40 €
180ABRVIENTDP304	230	270	22,37 €
200ABRVIENTDP304	250	290	23,41 €
250ABRVIENTDP304	300	340	25,35 €
300ABRVIENTDP304	350	390	31,40 €
350ABRVIENTDP304	450	490	34,84 €
400ABRVIENTDP304	500	540	38,07 €
450ABRVIENTDP304	550	590	47,57 €
500ABRVIENTDP304	600	640	49,67 €
550ABRVIENTDP304	650	690	63,47 €
600ABRVIENTDP304	700	740	70,28 €

Abrazadera pared (Inox 304)

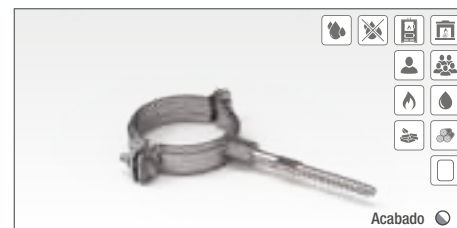

CÓDIGO	Ø	€/UD
130ABRSP304	130	7,58 €
150ABRSP304	150	8,16 €
170ABRSP304	170	8,75 €
180ABRSP304	180	9,33 €
200ABRSP304	200	9,91 €
230ABRSP304	230	11,08 €
250ABRSP304	250	11,66 €

Junta estanqueidad para repuesto



CÓDIGO	Ø	€/UD
8JTSPDPSIL	80	1,91 €
10JTSPDPSIL	100	1,93 €
130JTSPDPSIL	130	2,70 €
150JTSPDPSIL	150	3,71 €
180JTSPDPSIL	180	5,29 €
200JTSPDPSIL	200	6,05 €
250JTSPDPSIL	250	9,35 €
300JTSPDPSIL	300	11,14 €
350JTSPDPSIL	350	18,57 €
400JTSPDPSIL	400	21,23 €
450JTSPDPSIL	450	23,52 €
500JTSPDPSIL	500	25,95 €
550JTSPDPSIL	550	consultar
600JTSPDPSIL	600	consultar

TERMINALES

Terminal cónico libre (Inox 316)



CÓDIGO	Ø	Ø1	Ø2	A	€/UD
8FCONICODP316	80	130	180	197	45,24 €
10FCONICODP316	100	150	200	197	47,73 €
130FCONICODP316	130	180	230	197	49,60 €
150FCONICODP316	150	200	250	197	50,99 €
180FCONICODP316	180	230	280	197	52,86 €
200FCONICODP316	200	250	300	197	54,35 €
250FCONICODP316	250	300	350	197	65,57 €
300FCONICODP316	300	350	400	197	74,43 €
350FCONICODP316	350	450	450	197	91,41 €
400FCONICODP316	400	500	500	197	109,14 €
450FCONICODP316	450	550	550	197	134,82 €
500FCONICODP316	500	600	600	197	169,49 €
550FCONICODP316	550	650	650	197	375,62 €
600FCONICODP316	600	700	700	197	432,90 €

Deflector vertical antirretorno (Inox 316)



CÓDIGO	Ø	Ø1	Ø2	A	€/UD
8DFVARDP316	80	130	230	250	67,69 €
10DFVARDP316	100	150	250	250	71,75 €
130DFVARDP316	130	180	300	250	75,23 €
150DFVARDP316	150	200	300	250	93,16 €
180DFVARDP316	180	230	350	250	106,35 €
200DFVARDP316	200	250	350	250	124,93 €
250DFVARDP316	250	300	400	250	162,40 €
300DFVARDP316	300	350	450	250	197,20 €
350DFVARDP316	350	450	500	250	263,24 €
400DFVARDP316	400	500	550	250	280,34 €
450DFVARDP316	450	550	600	250	298,49 €
500DFVARDP316	500	600	650	250	353,84 €
550DFVARDP316	550	650	700	250	445,01 €
600DFVARDP316	600	700	750	250	485,99 €

Deflector vertical (Inox 316)



CÓDIGO	Ø	Ø1	Ø2	€/UD
8DFVDP316	80	130	230	61,77 €
10DFVDP316	100	150	250	65,90 €
130DFVDP316	130	180	300	68,62 €
150DFVDP316	150	200	300	85,52 €
180DFVDP316	180	230	350	97,42 €
200DFVDP316	200	250	350	114,73 €
250DFVDP316	250	300	400	148,21 €
300DFVDP316	300	350	450	159,44 €
350DFVDP316	350	450	500	178,20 €
400DFVDP316	400	500	550	192,60 €
450DFVDP316	450	550	600	235,94 €
500DFVDP316	500	600	650	289,86 €
550DFVDP316	550	650	700	500,19 €
600DFVDP316	600	700	750	612,82 €



Disponibles todas las piezas en acabado cobre. Consultar.

ChimeNOX®

Doble pared 304/304

DOBLE PARED (aislado Inox 304/304) _____

Conductos para evacuación de humos de combustión de calderas de gas o gasoil NO condensación en instalaciones individuales o colectivas en INTERIOR y EXTERIOR.

Características:

- Material interior: Acero inoxidable AISI 304.
- Material exterior: Acero inoxidable AISI 304.
- Material aislante: Lana de roca 25 mm. espesor
- Espesor mínimo: 0,5 mm.
- Combustible: Gas o gasoil NO condensación.
- Temperatura máxima:
 - 200°C con junta.
 - 600°C sin junta.
- Unión entre piezas: Machihembrada.
- Color: Acero inox.
- Junta de estanqueidad: Silicona.
- Designación de producto:
 - Sistema con junta:
 - EN1856-1-T200-P1-W-Vm-L20040-O(50)
 - Sistema sin junta:
 - EN1856-1-T600-N1-D-Vm-L20040-G(70)
- Diámetros disponibles:
 - ø100 - ø130 - ø150 - ø180 - ø200 - ø250 - ø300 - ø350 - ø400 - ø450 - ø500 - ø550 - ø600



Los dibujos de las piezas son orientativos, FIG S.L. se reserva el derecho de cambiar las características de los productos sin previo aviso.
Las dimensiones de las piezas son aproximadas, FIG S.L. no se hace responsable de problemas en la instalación de las mismas.



TERMINALES

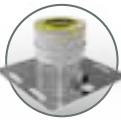

COMPLEMENTOS



ADAPTADORES



RECOGE CONDENSADOS



TUBOS Y CODOS

TUBOS

Tubo Macho - Hembra (Inox 304-Interior y Exterior)



CÓDIGO	Ø	Ø1	L	€/UD
10-500DP304	100	150	500	56,24 €
130-500DP304	130	180	500	62,14 €
150-500DP304	150	200	500	69,07 €
180-500DP304	180	230	500	77,52 €
200-500DP304	200	250	500	93,09 €
250-500DP304	250	300	500	111,97 €
300-500DP304	300	350	500	139,24 €
350-500DP304	350	450	500	149,94 €
400-500DP304	400	500	500	175,00 €
450-500DP304	450	550	500	193,42 €
500-500DP304	500	600	500	257,08 €

Tubo Macho - Hembra (Inox 304-Interior y Exterior)



CÓDIGO	Ø	Ø1	L	€/UD
10-1000DP304	100	150	1000	88,16 €
130-1000DP304	130	180	1000	96,18 €
150-1000DP304	150	200	1000	106,97 €
180-1000DP304	180	230	1000	119,10 €
200-1000DP304	200	250	1000	145,07 €
250-1000DP304	250	300	1000	184,69 €
300-1000DP304	300	350	1000	219,97 €
350-1000DP304	350	450	1000	256,49 €
400-1000DP304	400	500	1000	292,06 €
450-1000DP304	450	550	1000	321,32 €
500-1000DP304	500	600	1000	354,67 €

TUBOS TELESCÓPICOS

Tubo telescópico (Inox 304-Interior y Exterior)



CÓDIGO	Ø	Ø1	L. MÁX.	L. MIN.	€/UD
100TLDP304	100	150	884	507	109,64 €
130TLDP304	130	180	884	507	119,55 €
150TLDP304	150	200	884	507	132,96 €
180TLDP304	180	230	884	507	146,37 €
200TLDP304	200	250	884	507	174,95 €
250TLDP304	250	300	884	507	218,66 €
300TLDP304	300	350	884	507	251,14 €
350TLDP304	350	450	884	507	310,80 €
400TLDP304	400	500	884	507	375,05 €
450TLDP304	450	550	884	507	403,01 €
500TLDP304	500	600	884	507	415,56 €

CODOS

Codo 90° (Inox 304-Interior y Exterior)



CÓDIGO	Ø	Ø1	A	B	€/UD
10-90DP304	100	150	175	250	131,08 €
130-90DP304	130	180	186	276	139,20 €
150-90DP304	150	200	200	300	150,69 €
180-90DP304	180	230	210	325	174,17 €
200-90DP304	200	250	215	340	190,42 €
250-90DP304	250	300	252	402	230,04 €
300-90DP304	300	350	275	450	271,68 €
350-90DP304	350	450	327	552	401,75 €
400-90DP304	400	500	355	605	478,85 €
450-90DP304	450	550	380	655	694,32 €
500-90DP304	500	600	446	746	784,34 €

Codo 45° (Inox 304-Interior y Exterior)



CÓDIGO	Ø	Ø1	A	B	€/UD
10-45DP304	100	150	75	126	65,19 €
130-45DP304	130	180	79	141	74,52 €
150-45DP304	150	200	82	148	75,77 €
180-45DP304	180	230	87	159	87,85 €
200-45DP304	200	250	89	166	97,01 €
250-45DP304	250	300	97	184	117,15 €
300-45DP304	300	350	105	202	137,94 €
350-45DP304	350	450	118	237	205,46 €
400-45DP304	400	500	126	255	243,38 €
450-45DP304	450	550	133	272	348,80 €
500-45DP304	500	600	140	290	392,93 €

TES

Te 90° sin tapón (Inox 304-Interior y Exterior)



Acabado

CÓDIGO	Ø	Ø1	A	B	C	€/UD
10TE90DP304	100	150	440	242	150	113,68 €
130TE90DP304	130	180	440	242	165	121,72 €
150TE90DP304	150	200	440	242	175	125,93 €
180TE90DP304	180	230	440	242	190	179,66 €
200TE90DP304	200	250	440	242	200	190,50 €
250TE90DP304	250	300	440	242	225	231,68 €
300TE90DP304	300	350	440	270	250	269,34 €
350TE90DP304	350	450	440	320	300	457,88 €
400TE90DP304	400	500	440	345	325	539,96 €
450TE90DP304	450	550	440	370	350	602,25 €
500TE90DP304	500	600	440	390	375	720,70 €

Tape con purga (Inox 304-Interior y Exterior)



Acabado

CÓDIGO	Ø	Ø1	A	B	€/UD
10TAPECONDDP304	100	150	75	3/4"	26,18 €
130TAPECONDDP304	130	180	75	3/4"	31,44 €
150TAPECONDDP304	150	200	75	3/4"	31,95 €
180TAPECONDDP304	180	230	75	3/4"	33,47 €
200TAPECONDDP304	200	250	75	3/4"	38,34 €
250TAPECONDDP304	250	300	75	3/4"	45,49 €
300TAPECONDDP304	300	350	75	3/4"	51,98 €
350TAPECONDDP304	350	450	75	3/4"	165,48 €
400TAPECONDDP304	400	500	75	3/4"	186,83 €
450TAPECONDDP304	450	550	75	3/4"	206,54 €
500TAPECONDDP304	500	600	75	3/4"	225,15 €

TES

Junta estanqueidad para repuesto



CÓDIGO	Ø	€/UD
10JTSPDPSIL	100	1,93 €
130JTSPDPSIL	130	2,70 €
150JTSPDPSIL	150	3,71 €
180JTSPDPSIL	180	5,29 €
200JTSPDPSIL	200	6,05 €
250JTSPDPSIL	250	9,35 €
300JTSPDPSIL	300	11,14 €
350JTSPDPSIL	350	18,57 €
400JTSPDPSIL	400	21,23 €
450JTSPDPSIL	450	23,52 €
500JTSPDPSIL	500	25,95 €



El resto de accesorios (complementos, terminales, adaptadores, inspecciones) coinciden con los elementos de los apartados correspondientes de los elementos de Inox 316 / 316.

HP

SISTEMAS DE CONDUCTOS PARA EVACUACIÓN DE HUMOS DE GRUPOS
ELECTRÓGENOS



HP

.....
Conductos para evacuación de humos para grupos electrógenos.

Características.

- Material interior: Acero inoxidable AISI 304.
- Material exterior: Acero inoxidable AISI 304.
- Material aislante: Lana de roca 35 mm. espesor.
- Espesor mínimo pared interior: 0,5 mm.
- Unión entre piezas: Machihembrada.
- Junta estanqueidad: Silicona.
- Selladas con silicona.
- Temperatura máxima 600°C.
- Color Inox.
- Designación de producto:
 - T250-H1-W-Vm-L20050-O-50
 - T600-H2-D-Vm-L20050-O-75
- Diámetros disponibles:
 - ø80 - ø100 - ø125 - ø150 - ø175 - ø200 - ø250 - ø300 - ø350 - ø400 - ø450 - ø500 - ø550 - ø600

HP

HP

Conductos para evacuación de humos para grupos electrógenos.

Características.

- Material interior: Acero inoxidable AISI 304.
- Material exterior: Acero inoxidable AISI 304.
- Material aislante: Lana de roca 35 mm. espesor.
- Espesor mínimo pared interior: 0,5 mm.
- Unión entre piezas: Machihembrada.
- Junta estanqueidad: Silicona.
- Selladas con silicona.
- Temperatura máxima 600°C.
- Color Inox.
- Designación de producto:
 - T250-H1-W-Vm-L20050-O-50
 - T600-H2-D-Vm-L20050-O-75
- Diámetros disponibles:
 - ø80 - ø100 - ø125 - ø150 - ø175 - ø200 - ø250 - ø300 - ø350 - ø400 - ø450 - ø500 - ø550 - ø600



Los dibujos de las piezas son orientativos, FIG S.L. se reserva el derecho de cambiar las características de los productos sin previo aviso.
Las dimensiones de las piezas son aproximadas, FIG S.L. no se hace responsable de problemas en la instalación de las mismas.



TERMINALES



COMPLEMENTOS



ADAPTADORES



RECOGE CONDENSADOS



TUBOS Y CODOS



TUBOS

Tubos (inox 304)



Acabado

CÓDIGO	Ø	LONGITUD	€/UD
8-250HP	80	250	consultar
10-250HP	100	250	consultar
125-250HP	125	250	consultar
150-250HP	150	250	consultar
175-250HP	175	250	consultar
200-250HP	200	250	consultar
250-250HP	250	250	consultar
300-250HP	300	250	consultar
350-250HP	350	250	consultar
400-250HP	400	250	consultar
450-250HP	450	250	consultar
500-250HP	500	250	consultar
550-250HP	550	250	consultar
600-250HP	600	250	consultar

Tubos (inox 304)



Acabado

CÓDIGO	Ø	LONGITUD	€/UD
8-500HP	80	500	consultar
10-500HP	100	500	consultar
125-500HP	125	500	consultar
150-500HP	150	500	consultar
175-500HP	175	500	consultar
200-500HP	200	500	consultar
250-500HP	250	500	consultar
300-500HP	300	500	consultar
350-500HP	350	500	consultar
400-500HP	400	500	consultar
450-500HP	450	500	consultar
500-500HP	500	500	consultar
550-500HP	550	500	consultar
600-500HP	600	500	consultar

Tubos (inox 304)



Acabado

CÓDIGO	Ø	LONGITUD	€/UD
8-1000HP	80	1000	consultar
10-1000HP	100	1000	consultar
125-1000HP	125	1000	consultar
150-1000HP	150	1000	consultar
175-1000HP	175	1000	consultar
200-1000HP	200	1000	consultar
250-1000HP	250	1000	consultar
300-1000HP	300	1000	consultar
350-1000HP	350	1000	consultar
400-1000HP	400	1000	consultar
450-1000HP	450	1000	consultar
500-1000HP	500	1000	consultar
550-1000HP	550	1000	consultar
600-1000HP	600	1000	consultar

TUBOS TELESCÓPICOS

Tubo telescópico (inox 304)



Acabado

CÓDIGO	Ø	LONGITUD	€/UD
8TL500HP	80	500	consultar
10TL500HP	100	500	consultar
125TL500HP	125	500	consultar
150TL500HP	150	500	consultar
175TL500HP	175	500	consultar
200TL500HP	200	500	consultar
250TL500HP	250	500	consultar
300TL500HP	300	500	consultar
350TL500HP	350	500	consultar
400TL500HP	400	500	consultar
450TL500HP	450	500	consultar
500TL500HP	500	500	consultar
550TL500HP	550	500	consultar
600TL500HP	600	500	consultar

Tubo telescópico (inox 304)



Acabado

CÓDIGO	Ø	LONGITUD	€/UD
8TL1000HP	80	1000	consultar
10TL1000HP	100	1000	consultar
125TL1000HP	125	1000	consultar
150TL1000HP	150	1000	consultar
175TL1000HP	175	1000	consultar
200TL1000HP	200	1000	consultar
250TL1000HP	250	1000	consultar
300TL1000HP	300	1000	consultar
350TL1000HP	350	1000	consultar
400TL1000HP	400	1000	consultar
450TL1000HP	450	1000	consultar
1000TL1000HP	500	1000	consultar
550TL1000HP	550	1000	consultar
600TL1000HP	600	1000	consultar

CODOS

Codo 90° (inox 304)



Acabado

CÓDIGO	Ø	€/UD
8-90HP	80	consultar
10-90HP	100	consultar
125-90HP	125	consultar
150-90HP	150	consultar
175-90HP	175	consultar
200-90HP	200	consultar
250-90HP	250	consultar
300-90HP	300	consultar
350-90HP	350	consultar
400-90HP	400	consultar
450-90HP	450	consultar
500-90HP	500	consultar
550-90HP	550	consultar
600-90HP	600	consultar

Codo 45° (inox 304)



Acabado

CÓDIGO	Ø	€/UD
8-45HP	80	consultar
10-45HP	100	consultar
125-45HP	125	consultar
150-45HP	150	consultar
175-45HP	175	consultar
200-45HP	200	consultar
250-45HP	250	consultar
300-45HP	300	consultar
350-45HP	350	consultar
400-45HP	400	consultar
450-45HP	450	consultar
500-45HP	500	consultar
550-45HP	550	consultar
600-45HP	600	consultar

Codo 30° (inox 304)



Acabado

CÓDIGO	Ø	€/UD
8-30HP	80	consultar
10-30HP	100	consultar
125-30HP	125	consultar
150-30HP	150	consultar
175-30HP	175	consultar
200-30HP	200	consultar
250-30HP	250	consultar
300-30HP	300	consultar
350-30HP	350	consultar
400-30HP	400	consultar
450-30HP	450	consultar
500-30HP	500	consultar
550-30HP	550	consultar
600-30HP	600	consultar

TES

Te 90° sin Tapa (inox 304)



Acabado

CÓDIGO	Ø	€/UD
8TE90HP	80	consultar
10TE90HP	100	consultar
125TE90HP	125	consultar
150TE90HP	150	consultar
175TE90HP	175	consultar
200TE90HP	200	consultar
250TE90HP	250	consultar
300TE90HP	300	consultar
350TE90HP	350	consultar
400TE90HP	400	consultar
450TE90HP	450	consultar
500TE90HP	500	consultar
550TE90HP	550	consultar
600TE90HP	600	consultar

Te 45° sin tapa (inox 304)



Acabado

CÓDIGO	Ø	€/UD
8TE45HP	80	consultar
10TE45HP	100	consultar
125TE45HP	125	consultar
150TE45HP	150	consultar
175TE45HP	175	consultar
200TE45HP	200	consultar
250TE45HP	250	consultar
300TE45HP	300	consultar
350TE45HP	350	consultar
400TE45HP	400	consultar
450TE45HP	450	consultar
500TE45HP	500	consultar
550TE45HP	550	consultar
600TE45HP	600	consultar

Tapa con desagüe (inox 304)



Acabado

CÓDIGO	Ø	€/UD
8TAPAHP	80	consultar
10TAPAHP	100	consultar
125TAPAHP	125	consultar
150TAPAHP	150	consultar
175TAPAHP	175	consultar
200TAPAHP	200	consultar
250TAPAHP	250	consultar
300TAPAHP	300	consultar
350TAPAHP	350	consultar
400TAPAHP	400	consultar
450TAPAHP	450	consultar
500TAPAHP	500	consultar
550TAPAHP	550	consultar
600TAPAHP	600	consultar

ADAPTADORES

Adaptador simple a doble (inox 304)



Acabado

CÓDIGO	Ø	€/UD
8ADAPSPDPHP	80	consultar
10ADAPSPDPHP	100	consultar
125ADAPSPDPHP	125	consultar
150ADAPSPDPHP	150	consultar
175ADAPSPDPHP	175	consultar
200ADAPSPDPHP	200	consultar
250ADAPSPDPHP	250	consultar
300ADAPSPDPHP	300	consultar
350ADAPSPDPHP	350	consultar
400ADAPSPDPHP	400	consultar
450ADAPSPDPHP	450	consultar
500ADAPSPDPHP	500	consultar
550ADAPSPDPHP	550	consultar
600ADAPSPDPHP	600	consultar

SILENCIADORES E INSPECCIONES

Silenciador (inox 304)



Acabado

CÓDIGO	Ø	LONGITUD	€/UD
8SLHP	80	1000	consultar
10SLHP	100	1000	consultar
125SLHP	125	1000	consultar
150SLHP	150	1000	consultar
175SLHP	175	1000	consultar
200SLHP	200	1000	consultar
250SLHP	250	1000	consultar
300SLHP	300	1000	consultar
350SLHP	350	1000	consultar
400SLHP	400	1000	consultar
450SLHP	450	1000	consultar
1000SLHP	500	1000	consultar
550SLHP	550	1000	consultar
600SLHP	600	1000	consultar

Módulo de inspección (inox 304)



Acabado

CÓDIGO	Ø	LONGITUD	€/UD
8INSPHP	80	500	consultar
10INSPHP	100	500	consultar
125INSPHP	125	500	consultar
150INSPHP	150	500	consultar
175INSPHP	175	500	consultar
200INSPHP	200	500	consultar
250INSPHP	250	500	consultar
300INSPHP	300	500	consultar
350INSPHP	350	500	consultar
400INSPHP	400	500	consultar
450INSPHP	450	500	consultar
500INSPHP	500	500	consultar
550INSPHP	550	500	consultar
600INSPHP	600	500	consultar

COMPLEMENTOS

Soporte chimenea alta carga (inox 304)



Acabado

CÓDIGO	Ø	€/UD
8SOPCHIHP	80	consultar
10SOPCHIHP	100	consultar
125SOPCHIHP	125	consultar
150SOPCHIHP	150	consultar
175SOPCHIHP	175	consultar
200SOPCHIHP	200	consultar
250SOPCHIHP	250	consultar
300SOPCHIHP	300	consultar
350SOPCHIHP	350	consultar
400SOPCHIHP	400	consultar
450SOPCHIHP	450	consultar
500SOPCHIHP	500	consultar
550SOPCHIHP	550	consultar
600SOPCHIHP	600	consultar

Soporte mural (inox 304)



Acabado

CÓDIGO	Ø	€/UD
8SOPMURHP	80	consultar
10SOPMURHP	100	consultar
125SOPMURHP	125	consultar
150SOPMURHP	150	consultar
175SOPMURHP	175	consultar
200SOPMURHP	200	consultar
250SOPMURHP	250	consultar
300SOPMURHP	300	consultar
350SOPMURHP	350	consultar
400SOPMURHP	400	consultar
450SOPMURHP	450	consultar

TERMINALES

Deflector simple (inox 304)



Acabado

CÓDIGO	Ø	€/UD
8DFVHP	80	consultar
10DFVHP	100	consultar
125DFVHP	125	consultar
150DFVHP	150	consultar
175DFVHP	175	consultar
200DFVHP	200	consultar
250DFVHP	250	consultar
300DFVHP	300	consultar
350DFVHP	350	consultar
400DFVHP	400	consultar
450DFVHP	450	consultar
500DFVHP	500	consultar
550DFVHP	550	consultar
600DFVHP	600	consultar

Deflector cónico (inox 304)



Acabado

CÓDIGO	Ø	€/UD
8FCONOHP	80	consultar
10FCONOHP	100	consultar
125FCONOHP	125	consultar
150FCONOHP	150	consultar
175FCONOHP	175	consultar
200FCONOHP	200	consultar
250FCONOHP	250	consultar
300FCONOHP	300	consultar
350FCONOHP	350	consultar
400FCONOHP	400	consultar
450FCONOHP	450	consultar
500FCONOHP	500	consultar
550FCONOHP	550	consultar
600FCONOHP	600	consultar

Deflector pico flauta (Acero Inox 304)



Acabado

CÓDIGO	Ø	€/UD
8PICOFLAU90HP	80	consultar
10PICOFLAU90HP	100	consultar
125PICOFLAU90HP	125	consultar
150PICOFLAU90HP	150	consultar
175PICOFLAU90HP	175	consultar
200PICOFLAU90HP	200	consultar
250PICOFLAU90HP	250	consultar
300PICOFLAU90HP	300	consultar
350PICOFLAU90HP	350	consultar
400PICOFLAU90HP	400	consultar
450PICOFLAU90HP	450	consultar
500PICOFLAU90HP	500	consultar
550PICOFLAU90HP	550	consultar
600PICOFLAU90HP	600	consultar

Ei-30

SISTEMAS DE CONDUCTOS PARA EVACUACIÓN DE HUMOS DE
CAMPANAS EN COCINAS INDUSTRIALES Y SECTORIZACIONES





EI30 (ve ↔ o)

EI30 (ho ↔ o)

EI-30

Conductos para evacuación de humos de combustión, certificada EI30, para extracción de humos en cocinas industriales y ventilación de locales de riesgo de incendio.

Características:

- Material interior: Acero inoxidable AISI 304.
- Material exterior: Acero inoxidable AISI 304.
- Material aislante: Lana de roca 35 mm. espesor
- Espesor mínimo: 0,5 mm.
- Combustible: Gas o gasoil NO condensación.
- Temperatura máxima:
 - 200°C con junta.
 - 600°C sin junta.
- Unión entre piezas: Machihembrada.
- Color: Acero inox.
- Junta de estanqueidad: Silicona.
- Designación de producto:
 - Sistema con junta:
 - EN1856-2-T200-P1-W-Vm-L20040-O(00)
 - Sistema sin junta:
 - EN1856-2-T600-N1-W-Vm-L20040-O(45)
- Diámetros disponibles:
 - ø80 - ø100 - ø125 - ø150 - ø175 - ø200 - ø250 - ø300 - ø350 - ø400 - ø450 - ø500 - ø550 - ø600 - ø650 - ø700 - ø750 - ø800

EI-120 Consultar disponibilidad de material con mayor resistencia al fuego.

Ei-30

EI-30

Conductos para evacuación de humos de combustión, certificada EI30, para extracción de humos en cocinas industriales y ventilación de locales de riesgo de incendio.

Características:

- Material interior: Acero inoxidable AISI 304.
- Material exterior: Acero inoxidable AISI 304.
- Material aislante: Lana de roca 35 mm. espesor
- Espesor mínimo: 0,5 mm.
- Combustible: Gas o gasoil NO condensación.
- Temperatura máxima:
 - 200°C con junta.
 - 600°C sin junta.
- Unión entre piezas: Machihembrada.
- Color: Acero inox.
- Junta de estanqueidad: Silicona.
- Designación de producto:
 - Sistema con junta:
 - EN1856-2-T200-P1-W-Vm-L20040-O(00)
 - Sistema sin junta:
 - EN1856-2-T600-N1-W-Vm-L20040-O(45)
- Diámetros disponibles:
 - ø80 - ø100 - ø125 - ø150 - ø175 - ø200 - ø250 - ø300 - ø350 - ø400 - ø450 - ø500 - ø550 - ø600 - ø650 - ø700 - ø750 - ø800



Los dibujos de las piezas son orientativos, FIG S.L. se reserva el derecho de cambiar las características de los productos sin previo aviso.
Las dimensiones de las piezas son aproximadas, FIG S.L. no se hace responsable de problemas en la instalación de las mismas.



TERMINALES



COMPLEMENTOS



ADAPTADORES



RECOGE CONDENSADOS



TUBOS Y CODOS



TUBOS

Tubo (Acero Inox 304/304)



CÓDIGO	Ø1	Ø2	L	€/UD
8-250EI30	80	150	250	consultar
10-250EI30	100	170	250	consultar
125-250EI30	125	195	250	consultar
150-250EI30	150	220	250	consultar
175-250EI30	175	255	250	consultar
200-250EI30	200	270	250	consultar
250-250EI30	250	320	250	consultar
300-250EI30	300	370	250	consultar
350-250EI30	350	420	250	consultar
400-250EI30	400	470	250	consultar
450-250EI30	450	520	250	consultar
500-250EI30	500	570	250	consultar
550-250EI30	550	620	250	consultar
600-250EI30	600	670	250	consultar
650-250EI30	650	720	250	consultar
700-250EI30	700	770	250	consultar
750-250EI30	750	820	250	consultar
800-250EI30	800	870	250	consultar

Tubo (Acero Inox 304/304)



CÓDIGO	Ø1	Ø2	L	€/UD
8-500EI30	80	150	500	consultar
10-500EI30	100	170	500	consultar
125-500EI30	125	195	500	consultar
150-500EI30	150	220	500	consultar
175-500EI30	175	255	500	consultar
200-500EI30	200	270	500	consultar
250-500EI30	250	320	500	consultar
300-500EI30	300	370	500	consultar
350-500EI30	350	420	500	consultar
400-500EI30	400	470	500	consultar
450-500EI30	450	520	500	consultar
500-500EI30	500	570	500	consultar
550-500EI30	550	620	500	consultar
600-500EI30	600	670	500	consultar
650-500EI30	650	720	500	consultar
700-500EI30	700	770	500	consultar
750-500EI30	750	820	500	consultar
800-500EI30	800	870	500	consultar

Tubo (Acero Inox 304/304)



CÓDIGO	Ø1	Ø2	L	€/UD
8-1000EI30	80	150	1000	consultar
10-1000EI30	100	170	1000	consultar
125-1000EI30	125	195	1000	consultar
150-1000EI30	150	220	1000	consultar
175-1000EI30	175	255	1000	consultar
200-1000EI30	200	270	1000	consultar
250-1000EI30	250	320	1000	consultar
300-1000EI30	300	370	1000	consultar
350-1000EI30	350	420	1000	consultar
400-1000EI30	400	470	1000	consultar
450-1000EI30	450	520	1000	consultar
500-1000EI30	500	570	1000	consultar
550-1000EI30	550	620	1000	consultar
600-1000EI30	600	670	1000	consultar
650-1000EI30	650	720	1000	consultar
700-1000EI30	700	770	1000	consultar
750-1000EI30	750	820	1000	consultar
800-1000EI30	800	870	1000	consultar

TUBOS TELESCÓPICOS

Tubo telescópico corto (Acero Inox 304/304)



CÓDIGO	Ø1	Ø2	L. MÁX.	L. MIN.	€/UD
8TL500EI30	80	150	450	250	consultar
10TL500EI30	100	170	450	250	consultar
125TL500EI30	125	195	450	250	consultar
150TL500EI30	150	220	450	250	consultar
175TL500EI30	175	255	450	250	consultar
200TL500EI30	200	270	450	250	consultar
250TL500EI30	250	320	450	250	consultar
300TL500EI30	300	370	450	250	consultar
350TL500EI30	350	420	450	250	consultar
400TL500EI30	400	470	450	250	consultar
450TL500EI30	450	520	450	250	consultar
500TL500EI30	500	570	450	250	consultar
550TL500EI30	550	620	450	250	consultar
600TL500EI30	600	670	450	250	consultar
650TL500EI30	650	720	450	250	consultar
700TL500EI30	700	770	450	250	consultar
750TL500EI30	750	820	450	250	consultar
800TL500EI30	800	870	450	250	consultar

Tubo telescópico (Acero Inox 304/304)



CÓDIGO	Ø1	Ø2	L. MÁX.	L. MIN.	€/UD
8TL1000EI30	80	150	940	500	consultar
10TL1000EI30	100	170	940	500	consultar
125TL1000EI30	125	195	940	500	consultar
150TL1000EI30	150	220	940	500	consultar
175TL1000EI30	175	255	940	500	consultar
200TL1000EI30	200	270	940	500	consultar
250TL1000EI30	250	320	940	500	consultar
300TL1000EI30	300	370	940	500	consultar
350TL1000EI30	350	420	940	500	consultar
400TL1000EI30	400	470	940	500	consultar
450TL1000EI30	450	520	940	500	consultar
500TL1000EI30	500	570	940	500	consultar
550TL1000EI30	550	620	940	500	consultar
600TL1000EI30	600	670	940	500	consultar
650TL1000EI30	650	720	940	500	consultar
700TL1000EI30	700	770	940	500	consultar
750TL1000EI30	750	820	940	500	consultar
800TL1000EI30	800	870	940	500	consultar

CODOS

Codo 90° (Acero Inox 304/304)



Acabado

CÓDIGO	Ø1	Ø2	L	€/UD
8-90EI30	80	150	166	consultar
10-90EI30	100	170	187	consultar
125-90EI30	125	195	219	consultar
150-90EI30	150	220	231	consultar
175-90EI30	175	255	243	consultar
200-90EI30	200	270	260	consultar
250-90EI30	250	320	295	consultar
300-90EI30	300	370	320	consultar
350-90EI30	350	420	345	consultar
400-90EI30	400	470	419	consultar
450-90EI30	450	520	448	consultar
500-90EI30	500	570	475	consultar
550-90EI30	550	620	499	consultar
600-90EI30	600	670	526	consultar
650-90EI30	650	720	551	consultar
700-90EI30	700	770	576	consultar
750-90EI30	750	820	601	consultar
800-90EI30	800	870	627	consultar

Codo 45° (Acero Inox 304/304)



Acabado

CÓDIGO	Ø1	Ø2	L	€/UD
8-45EI30	80	150	98	consultar
10-45EI30	100	170	119	consultar
125-45EI30	125	195	155	consultar
150-45EI30	150	220	163	consultar
175-45EI30	175	255	172	consultar
200-45EI30	200	270	182	consultar
250-45EI30	250	320	201	consultar
300-45EI30	300	370	221	consultar
350-45EI30	350	420	237	consultar
400-45EI30	400	470	293	consultar
450-45EI30	450	520	317	consultar
500-45EI30	500	570	336	consultar
550-45EI30	550	620	353	consultar
600-45EI30	600	670	372	consultar
650-45EI30	650	720	390	consultar
700-45EI30	700	770	407	consultar
750-45EI30	750	820	425	consultar
800-45EI30	800	870	443	consultar

Codo 30° (Acero Inox 304/304)



Acabado

CÓDIGO	Ø1	Ø2	L	€/UD
8-30EI30	80	150	93	consultar
10-30EI30	100	170	112	consultar
125-30EI30	125	195	137	consultar
150-30EI30	150	220	143	consultar
175-30EI30	175	255	150	consultar
200-30EI30	200	270	159	consultar
250-30EI30	250	320	172	consultar
300-30EI30	300	370	184	consultar
350-30EI30	350	420	197	consultar
400-30EI30	400	470	254	consultar
450-30EI30	450	520	271	consultar
500-30EI30	500	570	284	consultar
550-30EI30	550	620	296	consultar
600-30EI30	600	670	309	consultar
650-30EI30	650	720	321	consultar
700-30EI30	700	770	334	consultar
750-30EI30	750	820	346	consultar
800-30EI30	800	870	359	consultar

TES

Te 90° sin tapón (Acero Inox 304/304)



Acabado

CÓDIGO	Ø1	Ø2	L	€/UD
8TE90EI30	80	150	263	consultar
10TE90EI30	100	170	288	consultar
125TE90EI30	125	195	313	consultar
150TE90EI30	150	220	338	consultar
175TE90EI30	175	255	363	consultar
200TE90EI30	200	270	400	consultar
250TE90EI30	250	320	453	consultar
300TE90EI30	300	370	502	consultar
350TE90EI30	350	420	553	consultar
400TE90EI30	400	470	598	consultar
450TE90EI30	450	520	649	consultar
500TE90EI30	500	570	703	consultar
550TE90EI30	550	620	811	consultar
600TE90EI30	600	670	865	consultar
650TE90EI30	650	720	911	consultar
700TE90EI30	700	770	965	consultar
750TE90EI30	750	820	1014	consultar
800TE90EI30	800	870	1067	consultar

Te 45° sin tapón (Acero Inox 304/304)



Acabado

CÓDIGO	Ø1	Ø2	L	€/UD
8TE45EI30	80	150	332	consultar
10TE45EI30	100	170	376	consultar
125TE45EI30	125	195	410	consultar
150TE45EI30	150	220	446	consultar
175TE45EI30	175	255	480	consultar
200TE45EI30	200	270	522	consultar
250TE45EI30	250	320	597	consultar
300TE45EI30	300	370	677	consultar
350TE45EI30	350	420	738	consultar
400TE45EI30	400	470	813	consultar
450TE45EI30	450	520	878	consultar
500TE45EI30	500	570	955	consultar
550TE45EI30	550	620	1083	consultar
600TE45EI30	600	670	1159	consultar
650TE45EI30	650	720	1225	consultar
700TE45EI30	700	770	1300	consultar
750TE45EI30	750	820	1370	consultar
800TE45EI30	800	870	1447	consultar

Tape con purga (Acero Inox 304)



Acabado

CÓDIGO	Ø1	Ø2	L	€/UD
8TAPAEI30	80	150	1/2"	consultar
10TAPAEI30	100	170	1/2"	consultar
125TAPAEI30	125	195	1/2"	consultar
150TAPAEI30	150	220	3/4"	consultar
175TAPAEI30	175	255	3/4"	consultar
200TAPAEI30	200	270	3/4"	consultar
250TAPAEI30	250	320	3/4"	consultar
300TAPAEI30	300	370	1"	consultar
350TAPAEI30	350	420	1"	consultar
400TAPAEI30	400	470	1"	consultar
450TAPAEI30	450	520	1"	consultar
500TAPAEI30	500	570	1"	consultar
550TAPAEI30	550	620	1"	consultar
600TAPAEI30	600	670	1"	consultar
650TAPAEI30	650	720	1"	consultar
700TAPAEI30	700	770	1"	consultar
750TAPAEI30	750	820	1"	consultar
800TAPAEI30	800	870	1"	consultar

ADAPTADORES

Adaptador simple a doble (Acero Inox 304/304)



Acabado

CÓDIGO	Ø1	Ø2	€/UD
8ADAPSPDPEI30	80	80	consultar
10ADAPSPDPEI30	100	100	consultar
125ADAPSPDPEI30	125	125	consultar
150ADAPSPDPEI30	150	150	consultar
175ADAPSPDPEI30	175	175	consultar
200ADAPSPDPEI30	200	200	consultar
250ADAPSPDPEI30	250	250	consultar
300ADAPSPDPEI30	300	300	consultar
350ADAPSPDPEI30	350	350	consultar
400ADAPSPDPEI30	400	400	consultar
450ADAPSPDPEI30	450	450	consultar
500ADAPSPDPEI30	500	500	consultar
550ADAPSPDPEI30	550	550	consultar
600ADAPSPDPEI30	600	600	consultar
650ADAPSPDPEI30	650	650	consultar
700ADAPSPDPEI30	700	700	consultar
750ADAPSPDPEI30	750	750	consultar
800ADAPSPDPEI30	800	800	consultar

SILENCIADORES E INSPECCIONES

Tramo inspección (Acero Inox 304/304)



Acabado

CÓDIGO	Ø1	Ø2	L	€/UD
8INSPEI30	80	150	263	consultar
10INSPEI30	100	170	288	consultar
125INSPEI30	125	195	313	consultar
150INSPEI30	150	220	338	consultar
175INSPEI30	175	255	363	consultar
200INSPEI30	200	270	400	consultar
250INSPEI30	250	320	453	consultar
300INSPEI30	300	370	502	consultar
350INSPEI30	350	420	553	consultar
400INSPEI30	400	470	598	consultar
450INSPEI30	450	520	649	consultar
500INSPEI30	500	570	703	consultar
550INSPEI30	550	620	811	consultar
600INSPEI30	600	670	865	consultar
650INSPEI30	650	720	911	consultar
700INSPEI30	700	770	965	consultar
750INSPEI30	750	820	1014	consultar
800INSPEI30	800	870	1067	consultar

Silenciador (Acero Inox 304/304)



Acabado

CÓDIGO	Ø1	Ø2	€/UD
8SLEI30	80	150	consultar
10SLEI30	100	170	consultar
125SLEI30	125	195	consultar
150SLEI30	150	220	consultar
175SLEI30	175	255	consultar
200SLEI30	200	270	consultar
250SLEI30	250	320	consultar
300SLEI30	300	370	consultar
350SLEI30	350	420	consultar
400SLEI30	400	470	consultar
450SLEI30	450	520	consultar
1000SLEI30	500	570	consultar
550SLEI30	550	620	consultar
600SLEI30	600	670	consultar
650SLEI30	650	720	consultar
700SLEI30	700	770	consultar
750SLEI30	750	820	consultar
800SLEI30	800	870	consultar

COMPLEMENTOS

Soporte chimenea alta carga (Acero Inox 304)



Acabado

CÓDIGO	Ø1	Ø2	L	€/UD
8SOPCHIEI30	80	223	303	consultar
10SOPCHIEI30	100	243	323	consultar
125SOPCHIEI30	125	263	343	consultar
150SOPCHIEI30	150	283	363	consultar
175SOPCHIEI30	175	313	343	consultar
200SOPCHIEI30	200	333	413	consultar
250SOPCHIEI30	250	383	363	consultar
300SOPCHIEI30	300	433	513	consultar
350SOPCHIEI30	350	483	563	consultar
400SOPCHIEI30	400	533	613	consultar
450SOPCHIEI30	450	583	663	consultar
500SOPCHIEI30	500	633	713	consultar
550SOPCHIEI30	550	683	763	consultar
600SOPCHIEI30	600	733	813	consultar
650SOPCHIEI30	650	783	863	consultar
700SOPCHIEI30	700	833	913	consultar
750SOPCHIEI30	750	883	963	consultar
800SOPCHIEI30	800	933	1013	consultar

Soporte mural (Acero Inox 304)



Acabado

CÓDIGO	Ø	A	€/UD
8SOPMUREI30	80	135	consultar
10SOPMUREI30	100	155	consultar
125SOPMUREI30	125	180	consultar
150SOPMUREI30	150	205	consultar
175SOPMUREI30	175	225	consultar
200SOPMUREI30	200	255	consultar
250SOPMUREI30	250	305	consultar
300SOPMUREI30	300	355	consultar
350SOPMUREI30	350	405	consultar
400SOPMUREI30	400	455	consultar
450SOPMUREI30	450	505	consultar
500SOPMUREI30	500	555	consultar
550SOPMUREI30	550	605	consultar
600SOPMUREI30	600	655	consultar
650SOPMUREI30	650	705	consultar
700SOPMUREI30	700	755	consultar
750SOPMUREI30	750	805	consultar
800SOPMUREI30	800	855	consultar

Junta de silicona

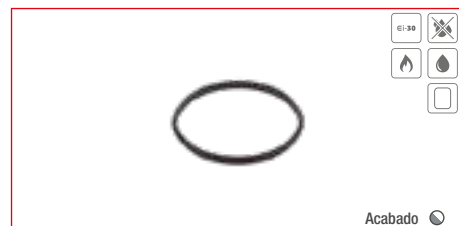

Acabado

CÓDIGO	Ø	€/UD
8JTSILEI30	80	consultar
10JTSILEI30	100	consultar
125JTSILEI30	125	consultar
150JTSILEI30	150	consultar
175JTSILEI30	175	consultar
200JTSILEI30	200	consultar
250JTSILEI30	250	consultar
300JTSILEI30	300	consultar
350JTSILEI30	350	consultar
400JTSILEI30	400	consultar
450JTSILEI30	450	consultar
500JTSILEI30	500	consultar
550JTSILEI30	550	consultar
600JTSILEI30	600	consultar
650JTSILEI30	650	consultar
700JTSILEI30	700	consultar
750JTSILEI30	750	consultar
800JTSILEI30	800	consultar

TERMINALES

Deflector simple (Acero Inox 304)



Acabado

CÓDIGO	Ø1	A	B	€/UD
8DFVEI30	80	340	80	consultar
10DFVEI30	100	365	100	consultar
125DFVEI30	125	390	125	consultar
150DFVEI30	150	415	150	consultar
175DFVEI30	175	450	160	consultar
200DFVEI30	200	475	185	consultar
250DFVEI30	250	525	210	consultar
300DFVEI30	300	600	240	consultar
350DFVEI30	350	678	255	consultar
400DFVEI30	400	780	270	consultar
450DFVEI30	450	855	300	consultar
500DFVEI30	500	930	330	consultar
550DFVEI30	550	1010	360	consultar
600DFVEI30	600	1085	390	consultar
650DFVEI30	650	1160	420	consultar
700DFVEI30	700	1235	450	consultar
750DFVEI30	750	1310	480	consultar
800DFVEI30	800	1385	510	consultar

Deflector pico flauta (Acero Inox 304)



Acabado

CÓDIGO	Ø	€/UD
8PICOFLAUEI30	80	consultar
10PICOFLAUEI30	100	consultar
125PICOFLAUEI30	125	consultar
150PICOFLAUEI30	150	consultar
175PICOFLAUEI30	175	consultar
200PICOFLAUEI30	200	consultar
250PICOFLAUEI30	250	consultar
300PICOFLAUEI30	300	consultar
350PICOFLAUEI30	350	consultar
400PICOFLAUEI30	400	consultar
450PICOFLAUEI30	450	consultar
500PICOFLAUEI30	500	consultar
550PICOFLAUEI30	550	consultar
600PICOFLAUEI30	600	consultar
650PICOFLAUEI30	650	consultar
700PICOFLAUEI30	700	consultar
750PICOFLAUEI30	750	consultar
800PICOFLAUEI30	800	consultar

COMPLEMENTOS

COMPLEMENTOS PARA INSTALACIONES DE CALEFACCIÓN



Tubo rollo 30 m.



CÓDIGO	MEDIDAS	Ø	€/UD
070227	30 m.	3/8"	218,73 €
070202	30 m.	1/2"	267,73 €
070212	30 m.	3/4"	382,78 €
070213	30 m.	1"	528,60 €

Tubo rollo



CÓDIGO	MEDIDAS	Ø	€/UD
070201	4 m.	3/8"	21,03 €
070205	4 m.	1/2"	38,89 €
070206	4 m.	3/4"	55,90 €
070230	4 m.	1"	72,91 €

Tuerca reductora



CÓDIGO	Ø	€/UD
070222	1/2" a 3/8"	3,16 €
070223	3/4" a 1/2"	4,60 €
070235	1" a 3/4"	7,08 €

Tuerca



CÓDIGO	Ø	€/UD
070221	3/8"	1,23 €
070210	1/2"	1,40 €
070211	3/4"	2,03 €
070224	1"	3,65 €

Plantilla



CÓDIGO	Ø	€/UD
037059	1/2" y 3/4"	42,14 €
AMB0005	3/8" y 1"	42,14 €

Cortatubo



CÓDIGO	Ø	€/UD
070217		51,00 €

Remachador universal para tuercas de 3/8", 1/2", 3/4" y 1"



CÓDIGO	Ø	€/UD
037055		130,02 €

Kit aguaflex



CÓDIGO	Ø	€/UD
037051/V		245,42 €

El Kit Aguaflex está formado por:
 20 tuercas
 Plantilla 1/2" y 3/4".
 Remachador tuercas de 3/8", 1/2", 3/4" y 1".
 Cortatubos.

Armarios



COMPLEMENTOS

Armario cubre calentador estanco (Acero pintado)



CÓDIGO	MEDIDAS	€/UD
800430250CALEST	800x430x250	83,46 €

Armario cubre calentador estanco (Acero pintado)



CÓDIGO	MEDIDAS	€/UD
800500400ARMESTP	800x500x400	95,00 €
900500400ARMESTG	900x500x400	99,00 €
1000550440ARMUNI	1000x550x440	107,00 €
800480300ARMPEQ	800x480x300	88,00 €



Los dibujos de las piezas son orientativos, FIG S.L. se reserva el derecho de cambiar las características de los productos sin previo aviso. Las dimensiones de las piezas son aproximadas, FIG S.L. no se hace responsable de problemas en la instalación de las mismas.

Tejadillo para armario cubrecaldera (Acero pintado)



CÓDIGO	MEDIDAS	€/UD
70600500TECHOARM	70x600x500	32,00 €

Kit calentador para exterior 610 a 80

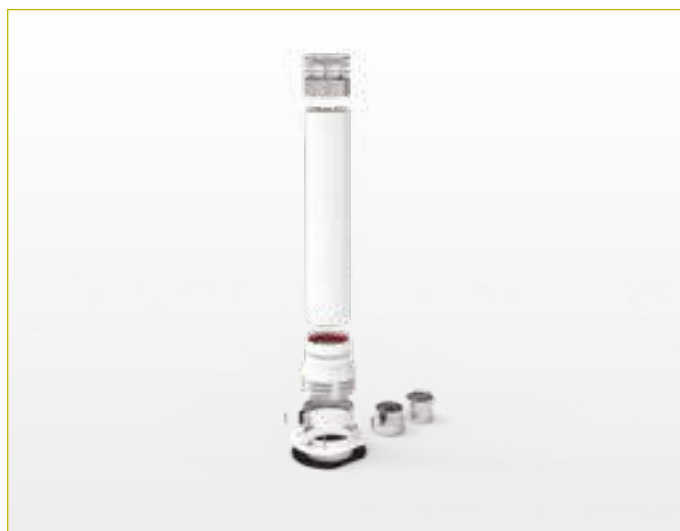

CÓDIGO	MEDIDAS	€/UD
6108KCCALEXTP1	800x500x400	58,85 €

IronPlaxt

Soporte Aire Acondicionado Metaloplástico

CÓDIGO	€/UD
SOPORTEAIRE45	35,70 €

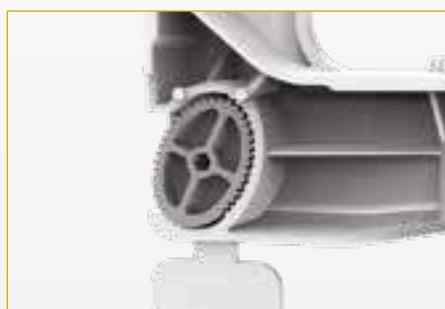

Detalle regulación nivel pared vertical mediante rueda excéntrica integrada.



Detalle interior metálico de 2 mm de grosor de una sola hoja doblado y nervados para mayor robustez.



Detalle Silents-Bloks integrados en el mismo molde termoplástico.

Soportes fabricados en una hoja de acero cincado de 2 mm de grosor por estampación con nervaduras para mayor rigidez, sin soldaduras ni uniones mecánicas por tornillos.
 Revestidos con material termoplástico que les otorga una gran resistencia a la corrosión y a los agentes atmosféricos.
 Silent-blocks integrados y posibilidad de regulación del ángulo de apertura mediante una rueda excéntrica situada en el lateral del soporte.

Características principales:

- Perfecta estabilidad dimensional y mecánica con temperaturas entre -10°C y 55°C.
- Gran resistencia al envejecimiento por radiación natural y salitre.
- Gran resistencia a bases y ácidos fuertes.
- Peso máximo admitido 100 kg por pareja.
- Tornillos y tuercas incluidos (4 unidades de cada).
- Color gris seda.
- Dimensiones:
 - Alto: 365 mm.
 - Ancho: 55 mm.
 - Largo: 490 mm.
 - Superficie útil apoyo máquina: 420 mm.

IronStrong

Fuerte y Seguro

CÓDIGO	€/UD
LCSOPORTEAIRE4	9,33 €

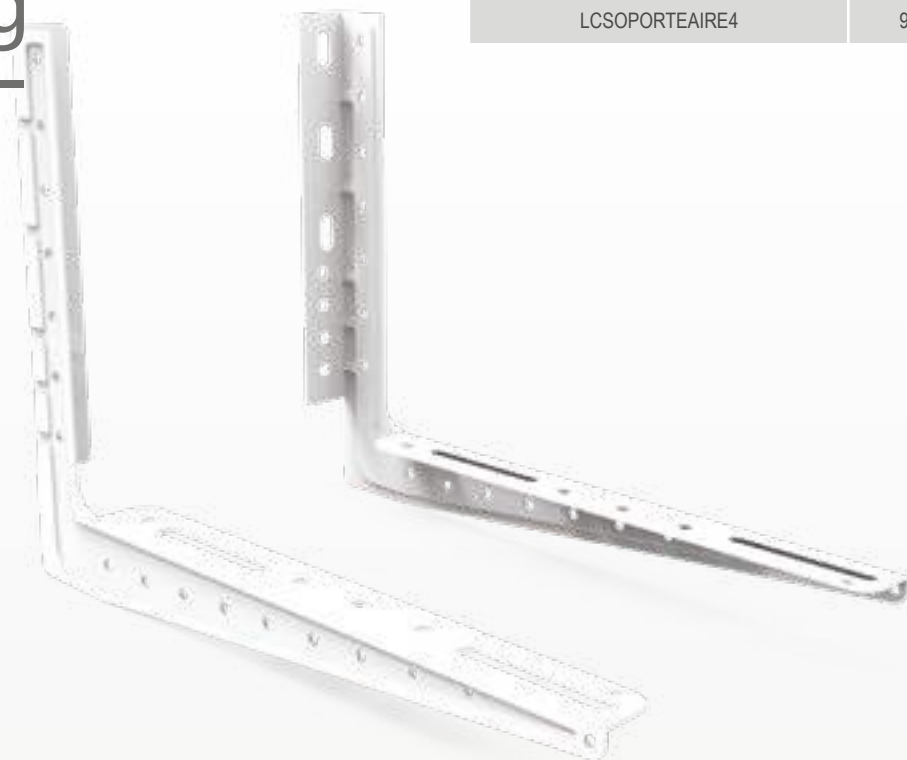

Máxima resistencia gracias al plegado por estampación de una sola hoja de acero de 2 mm. Sin soldaduras o uniones mecánicas.

Óptima resistencia a la intemperie gracias a un tratamiento anticorrosión y pintado epoxi de calidad. Color seda.

IronStrong, un nuevo soporte metálico para sujeción de máquinas de aire acondicionado. IronStrong está fabricado por estampación de una sola hoja de acero de 2 mm de espesor.

IronStrong tiene una resistencia de hasta 100 kg y es el único soporte que no presenta ninguna soldadura o unión mecánica en el ángulo, el punto de mayor esfuerzo.

IronStrong recibe un tratamiento anticorrosión y se termina con un recubrimiento de pintura epoxi de color SEDA. Esto le confiere una óptima resistencia a la intemperie.

IronStrong se comercializa en las medidas de:

- 350 mm en la vertical (fijación a pared)
- 450 mm en la horizontal (fijación a máquina)

Nebulizador

Nuvola

CÓDIGO	€/UD
NUVOLA	189,18 €



Una solución cómoda y práctica que además le aportará frescor en los días más calurosos. NUVOLA puede adaptarse a todos los aires acondicionados existentes sin modificar su funcionamiento. Montaje y mantenimiento rápido y sencillo.

Dimensiones:

- Alto: 155 mm
- Ancho: 155 mm
- Largo: 70 mm.



NUVOLA
condens

CÓDIGO	€/UD
NUVOLACONDENS	224,70 €



Kit con bomba de nebulización para calderas de condensación.

- Fácil instalación / sin obras
- No se necesita desagüe
- Alcance de hasta 50 m. en horizontal y 5 m. en vertical
- Capacidad de evacuar 5 l/h



CONDICIONES

DE VENTA

Precios

Los precios incluidos en esta tarifa tiene valor indicativo y no constituyen una oferta en firme por parte de FIG, S.L. Esta tarifa no incluye impuestos y anula todas las anteriores.

Características

FIG, S.L., se reserva el derecho de modificar las características de sus productos sin previo aviso.

Forma de pago

Pago a 60 días fecha factura. Toda mercancía es propiedad de FIG, S.L., hasta que no se haya hecho efectivo su cobro total conforme factura.

Suministro

Se suministrarán solamente cajas enteras.

Portes

Se enviará a portes pagados los pedidos por un importe neto superior a 600 euros. Envíos a Baleares portes pagados para pedidos por un importe neto superior a 1800 euros. Si el cliente desea modalidades de transporte diferentes a las elegidas por FIG, S.L., el envío se realizará a portes debidos. Consultar envíos a Ceuta, Melilla y Canarias.

Se recomienda comprobar el perfecto estado de los precintos y embalajes al recibir la mercancía, en caso de anomalías hacerlo constar en albarán de entrega de transporte, comunicando por escrito dichas anomalías a FIG, S.L., en un plazo máximo de 24 horas desde la recepción del envío.

Garantía

Todos nuestro productos están garantizados contra defectos de material o fabricación.

La garantía cubre el cambio o reparación de las piezas defectuosas (previa inspección de las mismas por FIG, S.L.) así como los portes que se originen, siempre y cuando los defectos no sean causados por un uso anormal.

Toda reclamación deberá notificarse por escrito a FIG, S.L., en un plazo de 24 horas a partir de la recepción de material.

Litigio

FIG, S.L., en caso de necesidad de competencias jurídicas se someterá expresamente a los Tribunales de Zaragoza.

Devolución de mercancía

En ningún caso se aceptarán devoluciones sin previa autorización de FIG, S.L. No se admitirán devoluciones de piezas fabricadas según diseño del cliente. Las devoluciones se aceptarán a portes pagados. Todas las devoluciones deberán ir acompañadas de fotocopia de la factura original. FIG, S.L., se reserva el derecho a examinar la mercancía devuelta, que para ser aceptada deberá estar en las mismas condiciones en que fue remitida al cliente (piezas y embalaje). En caso de producirse una devolución se generará una nota de cargo de un 10 % del valor neto en concepto de gastos derivados de la manipulación, recuento e inspección del producto devuelto.





FIG, S.L.

Polígono El Borao 9D · 50172 Alfajarín
Zaragoza · España

Tel. 976 10 70 46 · Fax 976 10 71 78
email: fig@fig.es

Apdo. de Correos 82
50171 La Puebla de Alfindén
Zaragoza · España

www.fig.es

